

---

!



ALPHA6000E ALPHA6000M

PG

36

RS-485

' ( ) \* + , - \$ . / 0 1 ! " # \$ % &  
45 67 89 : ; <

	" # \$
	u \$ = >? @ , A BC =D E&>?F GH I J: K L MN ; <F O \$
	u PQ RS (T: U V WX. Y Z/[ \ ] ^ _ ` / \ ] abc def WX ghij k ( T l m n opq r P s+ e >?
	u tu U v wxU V W 2 wx yz IEC * {   } ~ O•
	%&\$
	u F k F GH
	u j MOSFET k P2 d ef V WX IGBT j k s +
	' ( \$
	u O O 2 p O
	u t q o e t   u

) \* +, - . / O12345) 6789: ; <=>?@ABCDCEFG  
HI JKLDMNO, PQR FSTUV5W8XYZ

---

.....	1
8 RS .....	6
1.1 RS .....	6
1.2 & * + .....	6
1.3 .....	6
Q .....	7
2.1 F .....	7
2.1.1 .....	7
2.1.2 .....	7
2.1.3 P .....	8
2.2 F .....	8
2.3 Wwx .....	9
2.3.1 k .....	9
2.3.2 Wwx / 5 .....	10
2.3.3 Wwx Q .....	12
2.3.4 Wwx Q Z .....	13
2.4 Wwx .....	14
2.4.1 Wwx .....	14
2.4.2 Wwx Q .....	17
2.5 Q .....	19
2.6 Q 45; < .....	20
.....	21
3.1 ^_ .....	21
3.1.1 ^_ .....	21
3.1.2 ^ .....	22
3.1.3 LED Z / [ .....	22
3.1.4 ^_ .....	23
3.2 .....	24
3.3 .....	24
3.3.1 .....	24
3.3.2 . .....	24

---

---

3.3.3		.....	25	
	m	.....	26	
		.....	42	
5.1	P0	.....	42	
5.2	P1	.....	45	
5.3	!	P2	.....	50
5.4	I/O wx	P3	.....	54
5.5		P4	.....	64
5.6	PLC	P5	.....	66
5.8	PID	P7	.....	69
5.9		P8	.....	72
5.10	V/F	P9	.....	75
5.11		PA	.....	77
5.12	MODBUS	Pb	.....	79
5.13	` /	PC	.....	80
5.14		Pd	.....	82
5.15		PE	.....	86
5.16		PF	.....	87
		.....	90	
6.1	F	.....	90	
6.2	` / F	.....	91	
6.3	F	P	.....	92
	\$	.....	93	
7.1	\$	F g k	.....	93
7.2	\$		.....	95
7.2.1	u		.....	95
7.2.2			.....	95
7.2.3			.....	96
7.2.4	o		.....	96
			.....	97
8.1	F		.....	97
8.1.1			.....	97
8.1.2			.....	98

---

---

8.1.3	k	.....	98
8.2		.....	98
		.....	99
1		.....	101
2	*	.....	104
3	MODBUS	.....	106
4	^ _ _	.....	114
5		.....	115

[ \ ] ^ \_ ` a

1.1

\* s J A O1 RS s G

1.2

& \* +

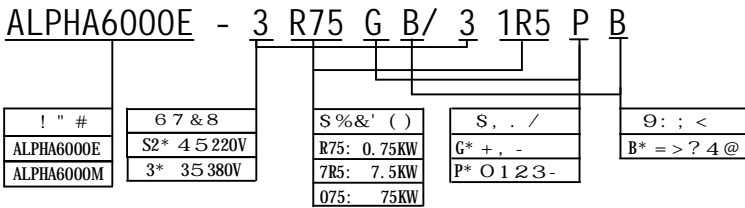

1-1

ALPHA6000E b ALPHA6000M R c d e f 8 g h i j k l m n 8 o p q r i j F s t u V / F b v w x y z f { | } ~ q r • SVC F V / F q r Z

ALPHA6000M-S2R4GB ALPHA6000M-S2R75GB ? v w x y z f { | } ~ q r • SVC Z

1.3

ALPHA6000M X - O / ALPHA6000E 8 } ~ :

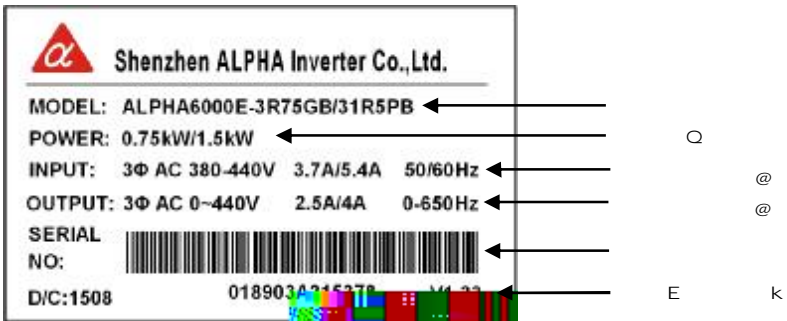

1-2



Q

1.3

@\ 2 t . @\ ] E ^ 9d j 2\_ \  
89 / 40( { | b T j pf 8 2 45  
-

2.2

e J f YZ&[ \* &Y YZc ' (Tt d {  
gX(h)(T # 2-1 2-2





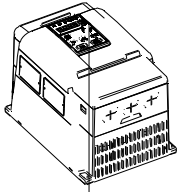



---

2.3.3

(2-9 1PH 220V 0.4&0.75kWHIJKLOW

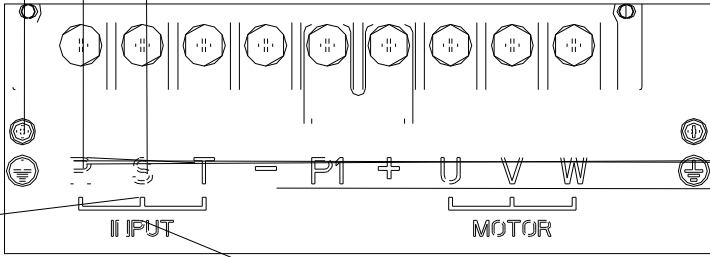



2.4

2.4.1

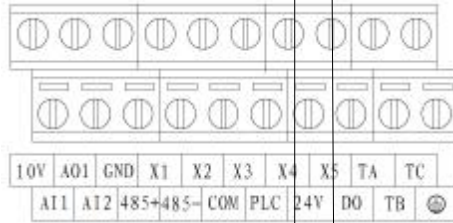

2-15 S2R4GB S2R75GB

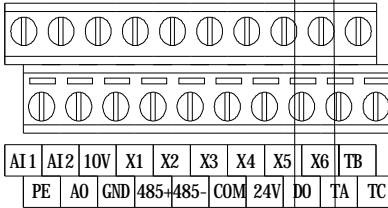

2-16 S21R5GB S22R2GB 3R75GB/31R5PB

( 2-17 639rsxrsIJKL[\ >2%/<=\\L7KLF&%@<=\\L&k#zBy=j 50m

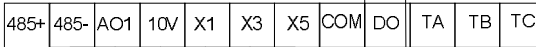

Wwx

2-2

	A11	1	@/ : SW3 @ \$ P4.05 S2R4GB S2R75GB SW1	@ n Q P4.00) A11 @ 0) 10V 30kt A11 0) 20mA 250t GND
	A12 S2R4 GB S2R75G B j	2	@ P4.06) P4.10 \$	A12 @ 0) 10V 639 -10V 10V 30kt GND
	AO		@/ Q : SW2 @ m/ 14 n P4.21 S2R4GB S2R75GB	. @ 0) 20mA/4) 20mA/ 0) 10V/2) 10V GND
	AO2		@/ Q : SW5 @ m/ 14 P4.22 639	. @ 0) 20mA/4) 20mA 0) 10V/2) 10V GND
	485+ RS485		485 U b w	O • RS-485 N GND mn

wx	X1	wx 1		N R=3.9kt
	X2	wx 2	wx 5.4 I/Owx	400Hz @
	X3	wx 3	P3 wx	0) 30V COM
	X4	wx 4	wx W S2R4GB S2R75GB I wx 5.4 I/Owx P3 wx	400Hz/50KHz(S21R5GB S22R2GB 3R75GB/31R5PB . ) @ 0) 30V COM
wx	X5	wx 5	wx W 5.4 I/Owx P3 wx	N R=3.9kt 50KHz @ 0) 30V COM
	X6 S2R4 GB S2R75G B j	wx 6	wx	

2.4.2

wx Q  
 AI1 AI2wx (S2R4GB  
 S2R75GB AI1) AI1Q : SW3 # @ { wx AO S2R4GB S2R75GB : SW2  
 @ 0) 10V 0) 20mA wx @/ m Z/  
 Q wx Q

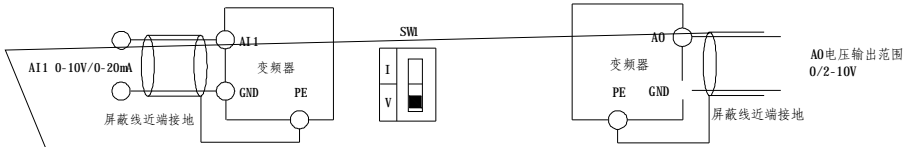

2-18

2-21 PLC

PC 3 PLC PC 2 F  
 8 RS232/RS485 PLC 2 t RS485w× F RS485w× z wJ  
 ! " # \$ % & ' (

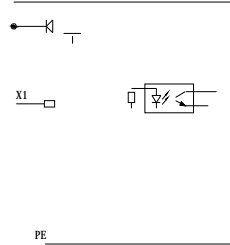
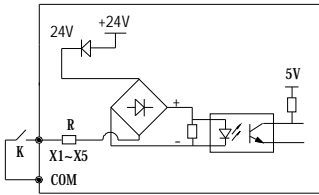

& BC\*

1pqr s 24Vt uv COMt u og Mwxmny } ~ • N  
 2p ` , a b&c \ Imm D } t uN  
 3p ` , a b&c ] M&c a b ~ t t Dk %~ g h gF  
 ~ g h} PEN

4p \ ] | > &c k & v & \ & \ A&' \ A & \ Ag g \ D  
 30cm M d I M | > &c v && M Z [ z { ? N

X. ^ \_ CN2 = RJ-4 n k . X X D XF  
 ^ \_ X 3 # ^ \_ < . 5 F 5 l . n ,  
 Z < = 5 l 6000E LED • CPU 8 Z  
 ^ \_ F X O • } RJ-4 { w EIA/TIA568B  
 O • ^ \_

## 2.5

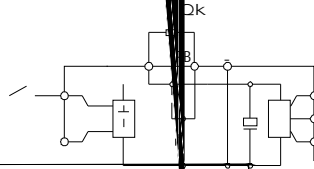

## 2.6

---



```

I      2  9      U
I      p 2  9      U 9 ; <
I      $      • 2      1000V s m $
I      {      4Mt
I      Z      m . mn      W .      MN W

I      89KL ~      W      mn . N / 50
I      9dtmn mn e { | $ q      =t mn X
I      @(T      @ sJA
I      p5 ; E      wx PE W wx PE (T      { | $
      v      W I *      W I * 8      ' (RS
      s j $      s      wxj b      s { | wx

```

# [ ]

 危険	<pre> 1  nwx \ U    d \ e &gt;? 2  d \$ D 2 G &gt;    ? </pre>
 注意	<pre> 1  2 {w @q W    def e F G &gt;? 2  8 n ! " ; &lt;    G &gt;? 3  dRS \$ 4  d 5 \$ 2p    \$ \$ </pre>

## 3.1

FJ: \* 3 8 ^\_Q z ^\_ LED ^\_ ^ F` / 8 Z  
 / [ Z / [ ^\_ \$ j Z

### 3.1.1

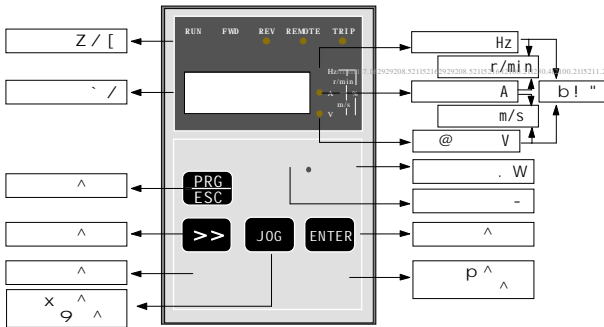



	: .	
REV C	Z / ]	8
	9 #	C
REV C	Z / : .	C
	: .	C
TRIP	Z / [ ]	
	. /	
REMOTE Z / [ ]		^ _
	#	wx
	. /	

3.1.4

^ \_ <  
 \ / 9

50.00 45.00 50.00 1440 1440

\$ \$

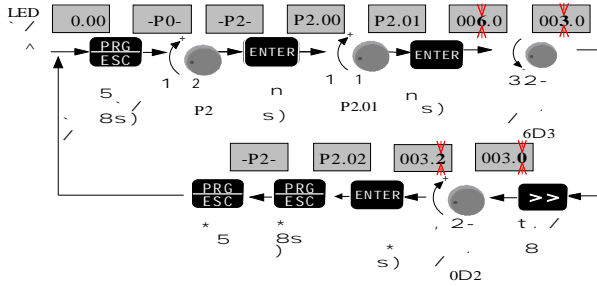

3-5  
s) O 8 . / m/ b  
I  
I R O  
I E \$ PF.01=1 22 p F 89~ O  
5 t PF.01 \$ 0 j ! " E

### 3.2

& GZ p Hw & Gb  
I ^\_ ^\_ p/ ^ x P2.51=1 ^  
I wx wx FWD REV COM { FWD REV HLD  
I p  
\$ l p 2 P0.07 \$ o \$ ^\_ ^  
P0.07 \$ 0 OQwx F p + wx O wx 2 p/ ^^  
+ wx STOP ^  
OQ ^\_ REMOTE Z/[ \] m ^\_ O x# m wx O  
./ m

### 3.3

#### 3.3.1

b y JOG x PID PLC 2 F?  
I JOG x x & ^\_x ^ P2.51=0 x  
I PID PID P2.00) P2.02 P0.03=11 t z FCJ  
I PLC 2 PLC P7 P0.03=10 t PLC z i \$  
P5 wx 44 t PLC t PLC P3 K  
I ? P3 wx 44 ^\_ \$ wx AI1  
F wx UP/DOWN U=> 7

#### 3.3.2

U z Q URS n ~ . p BL r  
U : . e \$ \ / 2 +





					MODBUS	
P0.15		0.00Hz)		0.00Hz	T	010F
P0.16	@	60) 480V		@	U	0110
P0.17	1 2	0 1 2 c b (1) 250)U(0.01Hz 1rpm) 1 2		0	U	0111
P0.18	2 1	d 132kW 0.1) 3600s e 160kW 1.0) 3600s		22kW 6.0s { 20.0s	T	0112
P0.19	2 1	d 132kW 0.1) 3600s e 160kW 1.0) 3600s		22kW 6.0s { 20.0s	T	0113

P1

						MODBUS
P1.00		0 1 (f J) 2 gh l( PG i h X 3004GB 3 gh 2( k ) 4 8 . j R j Q 89		0	T	0200
P1.01		0.10) 60.00Hz		0.50Hz	T	0201
P1.02	# 2	0.0) 10.0s		0.0s	T	0202
P1.03		y G 0) 100.0% P 0) 80.0% 0) 100.0% l V/F 80% Q P8.00 i f J => \$\$ / 2 100% 2 100%k		0.0%	T	0203
P1.04	2	0.0) 30.0s		0.1s	T	0204
P1.05	i	0.00Hz)		0.00Hz	U	0205
P1.06	i # 2	0.0) 3600s		0.0s	U	0206
P1.07		0 1 S l 2 ( j ) 3 ( j )		0	T	0207
P1.08	S l B 2	10.0) 50.0% 2 P1.08 P1.09d 90%		20.0%	T	0208
P1.09	S l . W 2	10.0) 80.0% 2 P1.08 P1.09d 90%		60.0%	T	0209
P1.10		0 1 Q 2 +		0	U	020A
P1.11		0.00) MIN[15.00Hz . ]		1.00Hz	T	020B
P1.12	m 2	0.00) 10.00s		0.00s	T	020C
P1.13	U \$	0 \$ 1 w x A l 1 2 w x A l 2 S2R4GB F S2R75GB j 3 j 4 5 ] 100%		0	T	020D
P1.14		y G 0.0) 100.0% P 0.0) 80.0%		0.0%	T	020E
P1.15	2	0.0) 30.0s		0.0s	T	020F
P1.16	#	0.00Hz)		0.00Hz	U	0210
P1.17	# 2	0.0) 3600.0s		0.0s	U	0211
P1.18		0 1 n 2 J 3 n F J		3	U	0212

m



					MODBUS	
P2.34	2	d 132kW 0.1) 3600s e 160kW 1.0) 3600s		22kW 3.0s {   10.0s	T	0322
P2.35	2 q	0 1 q 1 10 q 2 0.1 q		0	U	0323
P2.36	YZ &[	0 p 1 &[ 8		0	U	0324

					MODBUS
P3.03	X3 wx	0) 49 z . 50 e 51 i 53 2 74 wx 77 PID 0 78 PID c b 2 79 & 9 v ^ _ 45 46 52 54) 73 75 76 j	37	U	0403
S21R5GB S22R2GB 3R75GB/31R5PB					
P3.04	X4 wx	0) 79 z . 82 J B J	0	U	0404
P3.05	X5 wx	0) 79 z . 80 PULSE 81 J J A J	0	U	0405
P3.06	X6 wx	0) 79 z .	0	U	0406
S2R4GB S2R75GB					
P3.04	X4 wx	0) 79 z .	0	U	0404
P3.05	X5 wx	0) 79 z . 80 PULSE 81 J	0	U	0405
P3.06	j	-	-	*	0406
P3.07	j	-	-	*	0407
P3.08	j	-	-	*	0408
P3.09	j	-	-	*	0409
P3.10	j	-	-	*	040A
P3.11	j	-	-	*	040B
P3.12	j	-	-	*	040C
P3.13	X wx • 2	0.002s) 1.000s	0.010s	T	040D



					MODBUS
P4.12	/	-100.0%) 100.0%	0.0%	T	050C
P4.13		P4.11) 50.00kHz	50.00kHz	T	050D
P4.14		-100.0%) 100.0%	100.0%	T	050E
P4.15	j	-	-	*	050F
P4.16	j	-	-	*	0510
P4.17	j	-	-	*	0511
P4.18	j	-	-	*	0512
P4.19	j	-	-	*	0513
P4.20	j	-	-	*	0514
P4.21	A01	0 NULL 1 (0) 2 c q ) 2 @ (0) @) 3 PID (0) 10V) 4 PID C J (0) 10V) 5 W• (5V) 6 (0) 2 c q ) 7 (0) 2 c q ) 8 k @ (0) 1000V) 9 AI1 0) 10V/0) 20mA 10 AI2 0) 10V/0) 20mA S2R4GB F S2R75GB j 11 j 12 = > 0) 13 = > 0) 14 0) 2 c q	0	U	0515
P4.22	A02 639 X	0 NULL 1 (0) 2 c q ) 2 @ (0) @) 3 PID (0) 10V) 4 PID C J (0) 10V) 5 W• (5V) 6 (0) 2 c q ) 7 (0) 2 c q ) 8 k @ (0) 1000V) 9 AI1 0) 10V/0) 20mA 10 AI2 0) 10V/0) 20mA S2R4GB F S2R75GB j 11 j 12 = > 0) 13 = > 0) 14 0) 2 c q	0	*	0516
P4.23	j	-	-	*	0517
P4.24	D0	0) 14 z P4.21	0	U	0518
P4.25	A01	0 0) 10V/0) 20mA 1 2) 10V/4) 20mA	0	T	0519
P4.26	j	-	-		

P5 PLC

					MODBUS
P5.00		0 c 1 1 c 2 # z 2 c	2	U	0600
P5.01	PLC	0 8 B 1 2{ t 2 2{	0	U	0601
P5.02	2 PLC	0 1 \$ 0 2	0	U	0602
P5.03	t 2	0   1 b	0	U	0603
P5.04	2 T1	0.1) 3600	10.0	T	0604
P5.05	2 T2	0.0) 3600	10.0	T	0605
P5.06	2 T3		10.0	T	0606
P5.07	2 T4		10.0	T	0607
P5.08	2 T5		10.0	T	0608
P5.09	2 T6		10.0	T	0609
P5.10	2 T7	0.0) 3600	10.0	T	060A
P5.11	2 T8		10.0	T	060B
P5.12	2 T9		10.0	T	060C
P5.13	2 T10		10.0	T	060D
P5.14	2 T11		10.0	T	060E
P5.15	2 T12		10.0	T	060F
P5.16	2 T13		10.0	T	0610
P5.17	2 T14		10.0	T	0611
P5.18	2 T15		10.0	T	0612
P5.19	T1 \$	1 F/r ) 4 F/r	1F	T	0613
P5.20	T2 \$		1F	T	0614
P5.21	T3 \$		1F	T	0615
P5.22	T4 \$		1F	T	0616
P5.23	T5 \$		1F	T	0617
P5.24	T6 \$		1F	T	0618
P5.25	T7 \$		1F	T	0619
P5.26	T8 \$		1F	T	061A
P5.27	T9 \$		1F	T	061B
P5.28	T10 \$		1F	T	061C
P5.29	T11 \$		1F	T	061D
P5.30	T12 \$		1F	T	061E
P5.31	T13 \$		1F	T	061F
P5.32	T14 \$		1F	T	0620
P5.33	T15 \$		1F	T	0621
P5.34	i	0 1 0 0 R 0	0	U	0622
P5.35		0) 15	0	*	0623
P5.36	2	0.0) 3600	0.0	*	0624

---

**P7 PID**

					MODBUS
P7.00	Pghi				

					MODBUS	
P7.31	KP	0.01 ) 2.55		0.06	T	081F
P7.32	KP	0.01 ) 30.00		0.10	T	0820
P7.33	# 2	0.01 ) 999.9s		10.0s	T	0821

## P8

S2R4GB S2R75GB v} -qr F . 5

						MODBUS
P8.00	i f J =>	0.0) 500.0% 100.0% 80%F	2 P1.04 \$ /	100.0%	T	0900
P8.01	! y 1	0.1) 30.0		2.0	T	0901
P8.02	c b 2 1	0.001) 10.000s		y	T	0902
P8.03	9 1	0.00Hz) 9 2		20.00Hz	T	0903
P8.04	! y 2	0.1) 30.0		1.0	T	0904
P8.05	c b 2 2	0.001) 10.000s		y	T	0905
P8.06	9 2	9 1) 650.00Hz		150.00Hz	T	0906
P8.07	. 2	0.000s) 9.999s		0.001s	T	0907
P8.08	" . 2	0.0) 20.0ms		0.0	T	0908
P8.09	J	0.500) 1.024		0.900	U	0909
P8.10		0 1 2		0	T	090A
P8.11	\$ U	0 \$ 1 A11 2 A12 S2R4GB F S2R75GB j 3 j 4 5		0	U	090B
P8.12	.	G 0.0%) 200.0% P 0.0%) 150.0%		G 160.0% P 130.0%	T	090C
P8.13	.	G 0.0%) 200.0% P 0.0%) 150.0%		G 160.0% P 130.0%	T	090D
P8.14	\$ U =>	0.0%) 200.0%		102.4%	T	090E
P8.15	j	-		-	T	090F
P8.16	j	-		-	T	0910
P8.17	" U =>	50.0%) 200.0%		117.0%	T	0911
P8.18	" U =>	50.0%) 200.0%		117.0%	T	0912
P8.19	j	-		-	T	0913
P8.20	j	-		-	T	0914
P8.21	j	-		-	T	0915
P8.22	j	-		-	T	0916
P8.23	i W	0.0) 50.0%		0.0%	T	0917
P8.24	i a	0) 20%		5%	T	0918
P8.25	\$ U	0 P8.11 z \$ 8T 1 A11 2 A12 S2R4GB F S2R75GB j 3 j 4 5		0	U	0919
P8.26	=> y	40.0%) 160.0%		100.0%	T	091A
P8.27	=>y	0 => 1 => j 2 j		0	T	091B
P8.28	i f J 2	0.05) 10.00s		y	T	091C

P9 V/F

					MODBUS
P9.00	V/F I \$	0 9 # }   0 1 - }   1 2.0 2 - }   2 1.5 3 - }   3 1.2 4 \$ V/F I Q P9.01) P9.06	0	U	0A00
P9.01	V/F F1	0.0) P9.03	10.00Hz	U	0A01
P9.02	V/F @ V1	0.0) 100.0%	20.0%	U	0A02
P9.03	V/F F2	P9.01) P9.05	25.00Hz	U	0A03
P9.04	V/F @ V2	0.0) 100.0%	50.0%	U	0A04
P9.05	V/F F3	P9.03) P0.09	40.00Hz	U	0A05
P9.06	V/F @ V3	0) 100.0%	80.0%	U	0A06
P9.07	W	0.0 W 0.1) 30.0% W	75kw 0.0% 93kw . 0.1%	T	0A07
P9.08	W\$px	0.00) 50.00Hz	16.67Hz	T	0A08
P9.09	U =>	0.0) 250.0% 100%	75kw 80.0% 93kw . 0.0%	T	0A09
P9.10	U=>2	0.10) 25.00s	2.00s	T	0A0A
P9.11		0 1 4 > P0.09/4 2	0	U	0A0B
P9.12	%& * 2	100) 65530	5800	*	0A0C
P9.13	n U	0) 40	3	*	0A0D
P9.14	j			*	0A0E
P9.15	j			*	0A0F
P9.16	AVR	0 1 8 2 2	2	U	0A10
P9.17		0 1 1 2 2 4 V220 #	0	U	0A11
P9.18	d ( ' b Q)	0.00) 10.00Hz	0.00Hz	T	0A12
P9.19	@b U	0 \$ 1 wx A11 2 wx A12 S2R4GB F S2R75GB j 3 j 4 5 ] @ 100% I V/F b N	0	U	0A13
P9.20	@b	0.0%) 100.0%	0.0%	T	0A14
P9.21	( ) *	50) 500	100	U	0A15
P9.22	j	1.0) 4.0	2.4	U	0A16
P9.23	j	1.00) 1.10	1.00	U	0A17
P9.24	j	0) 100s	15s	U	0A18
P9.25	j	2) 100ms	10ms	U	0A19

PA:

					MODBUS			
PA.00		0	1	1	2	0	U	OB00
PA.01	1	2)	56			4	U	OB01
PA.02	1	0.4)	999.9kW			y	U	OB02
PA.03	1	0)	24000r/mi n				T	OB03
PA.04	1	0.1)	999.9A				U	OB04
PA.05	1	10	0.1)	999.9A			U	OB05
PA.06	1	x	R1	0.001)	65.00t		T	OB06
PA.07	1	x	L1	0.1)	2000mH		T	OB07
PA.08	1	x	R2	0.001)	65.00t		T	OB08
PA.09	1	+	Lm	0.1)	2000mH		T	OB09
PA.10	1	J , F	1	0.0%)	100.0%		T	OB0A
PA.11	1	J , F	2	0.0%)	100.0%		T	OB0B
PA.12	1	J , F	3	0.0%)	100.0%		T	OB0C
PA.13	1	J , F	4	0.0%)	100.0%		T	OB0D
PA.14	1	J , F	5	0.0%)	100.0%		T	OB0E
PA.15	2	2)	56				4	U
PA.16	2	0.4)	999.9kW			y	U	OB10
PA.17	2	0)	24000r/mi n				T	OB11
PA.18	2	0.1)	999.9A				U	OB12
PA.19	2	10	0.1)	999.9A			U	OB13
PA.20	2	x	R1	0.001)	65.00t		T	OB14
PA.21	2	x	L1	0.1)	2000mH		T	OB15
PA.22	2	x	R2	0.001)	65.00t		T	OB16
PA.23	2	+	Lm	0.1)	2000mH		T	OB17
PA.24	2	J , F	1	0.0%)	100.0%		T	OB18
PA.25	2	J , F	2	0.0%)	100.0%		T	OB19
PA.26	2	J , F	3	0.0%)	100.0%		T	OB1A
PA.27	2	J , F	4	0.0%)	100.0%		T	OB1B
PA.28	2	J , F	5	0.0%)	100.0%		T	OB1C
PA.29		S2R4GB	0	1	p		0	U
PA.30	F S2R75GB	j	2	1		-	*	OB1E

PC 〃 /



					MODBUS	
		3	4	\$		
Pd. 05	x ,	20)	110%		100%	T OE05
Pd. 06	i R	20.0)	200.0%		160.0%	U OE06
Pd. 07	i R 2	0.0)	60.0s		60.0s	U OE07
Pd. 08	^	0	1	9	1	T OE08
		2	9			
		3	2-			
Pd. 09	^	G 30)	180%		G 160%	T OE09
		P 60)	140%		P 120%	
Pd. 10	@	0	p	245		
		1	!	"		

			MODBUS
	1	T	0F00
u @ W @ @ ^ _ AD CPU K L	NULL	*	0F01
	0.00Hz	*	0F02
	0.00Hz	*	0F03
	0.0A	*	0F04
	0V	*	0F05

S

PF

7

					MODBUS
PF.00	?	0 ? {   ?	0	T	1000
PF.01	O	0 j ! " E O 1 . \$ P0.02 F {   2 . P O j p O	0	T	1001
PF.02	BL	0 2 R \$ ( \? \ . ) 3 R \$ ( \? . )	0	U	1002
PF.03	@A	0 2 . @A ^ _ 4	0	U	1003
PF.04	G/P	0 G (9 ) 1 P (& C} )	0	U	1004
PF.05	j	j	-	*	1005
PF.06	j	-	-	*	1006
PF.07	j	-	-	*	1007
PF.08	j	-	-	*	1008
PF.09		0) 9999		*	1009
PF.10	k	0.00) 99.99		*	100A
PF.11	O F	0.000) 9.999		*	100B
PF.12	k 7	0) 9999		*	100C

# [ ] n

## 5.1 P0

P0.00 ) \ /	\$ 0 1D0E
-------------	-----------

0 O•) 1 WX )  
 P0.00 \$ 1 2 ) WX 1 2 SFF V E  
 { G E t \ / M 0 j \ /

P0.01	\$ 0) 3D0E
-------	------------

0 V/F 1 j  
 2 3 V/FbN  
 \* V/F | 8| . {  
 Hw H 67  
 2 ? S2R4GB F S2R75GB  
 V/FbN I J F @

& BC\*

L | > 1 ] M ` , ~ q ~ &' Mx ^ \_ I &' M  
 d &' 7 ~ &' M f ~ | > nM  
 I v &' 7 r I L | > 5 M ! P8 " L | > ; < N  
 # S % | > 1 &M ' ( &' ) n | > ( &' M\* ( ) + , &' ( ) + q -  
 5. / M &' ~ ( ) + m O ( ) + / + 1 + Mwx s 2 3 | > n . 4 5 ' N

P0.02 \$	\$ 0.00Hz) D0.00HzE
----------	---------------------

\* P0.03 P0.04=1 2 ^ \_ \$ 2 | . \$

& BC\*

P0.02~ 6, 7 8 9 : ; ? < = > ? @ M ABCENTERG < M > DE F YM > ` G &  
 Hq y I J N  
 P0.03 7 1MK, ( n P3.18ML P3.18 7 2] M 7 7 ) P0.02D \ M < ~ 6G  
 &ND q 2] MG & q NDN

P0.03 \$ U 1	\$ 0) 11D1E
--------------	-------------

0 NULL 1 ^ \_ \$ 1 2 2 wx All  
 3 wx AI2(S2R4GB S2R75GB j ) 4 j 5  
 6 7 j 8  
 9 wx UP/DOWN 10 2 PLC 11 PID

P0.04 \$ U 2	\$ 0) 9D0E
--------------	------------

0 NULL 1 ^ \_ \$ 1 2 2 wx All  
 3 wx AI2(S2R4GB S2R75GB j ) 4 j 5

6  
 9 U=>  
 \* P0.03 \$ 1 ^\_ \$ 2 ^\_ 1 2 \$ \$ \$  
 P0.02 J : 2 ^\_ 1 2 P0.02  
 wx AI1 AI2 wx AI1 AI2 2 0) 10V @ 0) 20mA  
 } WX. J : z 2.4 WQ  
 wx AI1 AI2 / : & P4  
 \$ t PC PLC Q \$  
 P0.03 \$ 9 2 P3 UP/DOWN' ( U U 8  
 P0.04 \$ 9 2 => \$

P0.05	\$ 1	\$ 0) 9D0E
P0.06	\$ 2	\$ 0) 9D0E

0 \$ U 1 1 \$ U 2  
 2 MIN \$ U 1 \$ U 2 3 MAX \$ U 1 \$ U 2  
 4 \$ U 1 \$ U 2 5 \$ U 1 Z \$ U 2  
 6 \$ U 1 U \$ U 2 7 \$ U 1 [ \$ U 2  
 8 | \$ U 1 Z \$ U 2 | 9 \$ U 2 U \$ U 1 [  
 \* \$ U 1 \$m P0.03 \$ U 1  
 \$ U 2 \$m P0.04 \$ U 2  
 Q \$ U 1 F \$ U 2 J z  
 O SFC wx P3.01) P3.05 C wx + P0.06 \$ 2 2  
 \$ O FC wx wx wx + P0.05 \$ 1  
 2 \$ { z \$ g 5 9  
 O 6 7 + \$ U 2 \$ \$m

P0.07	& \$	\$ 0) 5D0E
-------	------	------------

0 ^\_ 1 wx 1(STOP ^ )  
 2 wx 2(STOP ^ ) 3 1(STOP ^ )  
 4 2(STOP ^ ) 5 wx 3(STOP JOG ^ )  
 1\* ^\_ 2 ^\_ RUN STOP^ F p wx 2  
 wx F p RUN F/R FWD REV HLD P3.01) P3.05 Q  
 2 t PC PLC Q p C  
 2\* STOP^ 2 ^\_ STOP^ p KL STOP^ 2  
 I \$ p  
 P0.07 \$ 5 2 ^\_ JOG^ F STOP^ JOG^ 2 ^\_ JOG^ I  
 wx x x  
 ^\_ F wx 2 E MN

P0.08	^_ \$	\$ 0 1D0E
-------	-------	-----------

0 1 C  
 \* S JOG P2.51=1 z 2 P0.08 \$  
 O OP +I ENTER ^ n

+Q Y S wx Y s ^ \_ Y s 2

P0.09	\$ 0.10) 650.0Hz j 0.1) 1000Hz
P0.10	\$ MAX[50.00Hz . \$ \ ) 650.0HzD50.00HzE j MAX[50.0Hz . \$ \ ) 1000HzD50.0HzE

\* F<sub>BASE</sub> \$ @ @U<sub>N</sub>2 / D F<sub>BASE</sub> } Q

5-0-1 \$ 2 ( T } 7 4 5 V/F} Q

F \$ F<sub>MAX</sub> ! " \$ +

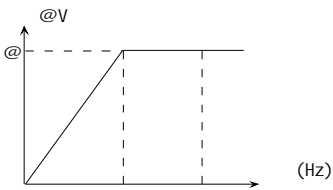

5-0-1

P0.11 . U	\$ 0) 5D0E
-----------	------------

0 \$ 1 wx All

2 wx AI2(S2R4GB S2R75GB j ) 3 j

4 5

\* 0\$ 2 .

\$ 02 12 # \$ 12V1 1 \$ V1 1  
 \$ (P0.17 30) (0.01Hz 1rpm)  
 \$ % \$ 2 P0.17 0.01Hz \$ 2 ? P0.17 (6 (5  
 S ))rpm PID + P0.17 1rpm  
 ? \$ P0.17=100 2 1 ^\_. 1 2 1 \$  
 / 30.00Hz + / 900rpm \$ P0.17=10 2+ 3.00Hz 90rpm PID \$  
 P0.17=10 2 1 ^\_. 1 2 1 / 300rpm

P0.18	2 1	\$ 0.1) 3600sD6.0s/20.0sE
P0.19	2 1	\$ 0.1) 3600sD6.0s/20.0sE

\* 2 i . W 2 2 Q v p2 2  
 2 3 2 { G P2.28) P2.33 j wx z  
 2 n |. P2.35 2 q t \$ 2 T/ q 10q

## 5.2 P1

P1.00	\$ 0) 2D0E
-------	------------

0 1 (f J)  
 2 gh 1 3 gh 2  
 \*

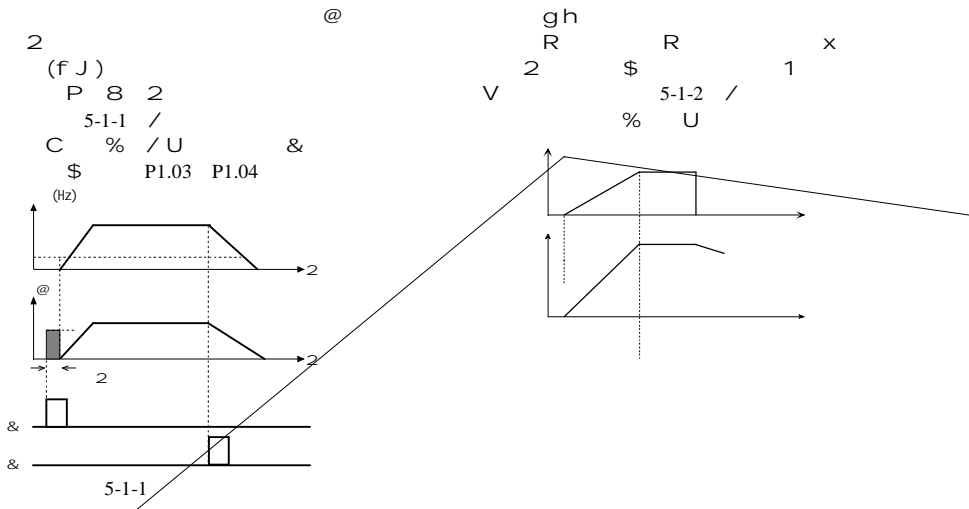

---

P1.01	\$	0.10) 60.00HzD0.50HzE
P1.02 # 2	\$	0.0) 10.0sD0.0sE

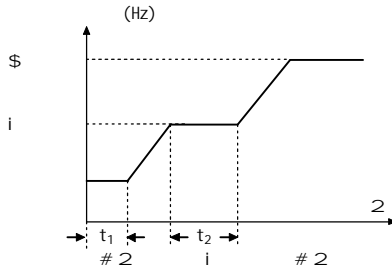

5-1-4

& BC\*

Z? bI ) 1 Z? ) A/ 7 ) Z? bI Nc ) ] d 0] MZ? bI ) 4@N

P1.07	\$	0) 3D0E
-------	----	---------

0 1 SI

2 j 3 j

+, 8W z 9 X Y Y 5-1-5 /

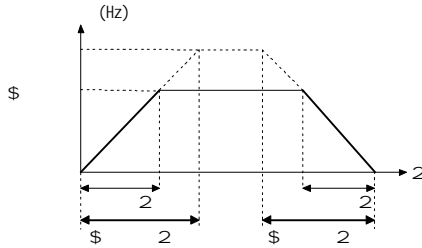

5-1-5

SI BF2\_2 ; 4 ZP ( /  
2 Y 2 2 2 =

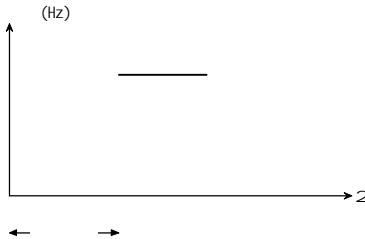

---

SI 2\_ 2 5-1-6 [ / F ^ L X +AY 0

& BC\*

Se \: f O1 MS g hi . /~j kMl &mAhn= N



& BC:

%( n gWk' op<Z, M ', Bqk' rj Mqn, ' ] ~f O>?N  
Rst Ok' ru~v Mk: wx??>4@ , Rx??>( n~' - N

P1.16	#	\$	0.00Hz)	D0.00HzE
P1.17	# 2	\$	0) 3600.0sD0.0sE	

# STOP ^ { k - #  
- 0  
\$ # 2 02 # \$ \$ # 2 #

P1.18	\$	0) 3D3E
-------	----	---------

0 1 n  
2 J 3 nFJ

& BC\*

y . /z q { / | \* y f O ] d } R~ • ru~v Mm qg>? & | ) ` , >?  
| y / 2 ? z L M d \* r t O k ' ~ v M s % I { 1 3 d , % ~ n > ?  
4 @ V > ? & N  
15kWV & ' - F I n > ? 4 @ N

P1.19	n	\$	30.0) 100.0%D100.0%E
-------	---	----	----------------------

\$ c c : W t c \$ d  
F n @ x F @ x Pd.11 : 380V n @ ! @  
x e 52V( n x 700V) 220V e 23V( n x 350V) o Pd.11

P1.20	j l	\$	0) 2D0E
-------	-----	----	---------

0 j Uu1 1 j 2 , Uu Uu1  
2 j , Uu

P1.21	j 2	\$	0.5) 10.0sDy E
-------	-----	----	----------------

P1.22	j ,	\$	0) 1D0E
-------	-----	----	---------

0 1

P1.23	j 2	\$	0.10Hz/s) /sD10.00Hz/sE
-------	-----	----	-------------------------

\* 2 u@ + l , Uu 2 D 5-1-8 /  
2 u@ Uu Uu1 5-1-8 / E Uu 2 Xf 0 R  
+ Uu g E Uu1 2 + - @v 300V + 3  
R Uu1  
j , 1 2 j , z P1.23 j 2 h R  
+ \$ 2 R \$

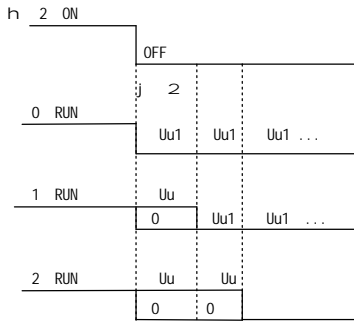
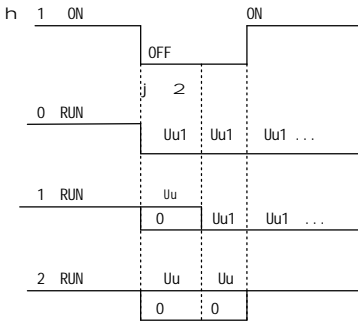

5-1-8

### 5.3 P2

P2.00 x		\$ 0.10Hz	D5.00HzE
P2.01 x	2	\$ 0.1)	3600sD6.0/20.0sE
P2.02 x	2	\$ 0.0)	3600sD6.0/20.0sE

P2.00) P2.02 x 2 J :  
 5-2-1 / t<sub>1</sub> t<sub>3</sub> x F 2 t<sub>2</sub> x 2 P2.00 x  
 Q P2.01 F P2.02 \$ x 2 0 2  
 x 2 t<sub>1</sub> z P2.02 \$ z x 2 t<sub>3</sub> 3  
 + Q P2.02 \$ \$ P2.02 \$ 0 2 0 P2.02 \$ 0 2

$$t_1 = \frac{x Ux 2}{x}$$

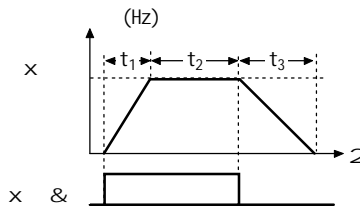

5-2-1

& BC\*

1p ? B j ? 1 0 j ? M ? : f O] d 4 H 7 N  
 2p ? f O] d 0 k M ? Mk' K > ? t u R @ k' ] M B f O] d 4 f  
 O  
 3p } A | > t u m ? | > N

P2.03 C 9 2		\$ 0.0)	3600sD0.0sE
* Q i C		QC	i i l m
i 2	5-2-2 / t <sub>1</sub>		

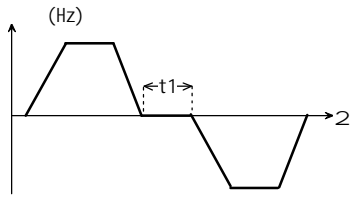

5-2-2 !

P2.04	l	\$	0) 3D0E
-------	---	----	---------

0 1 0  
 2 3 j  
 \* 0 2 \$ / + \$  
 5-2-3 /

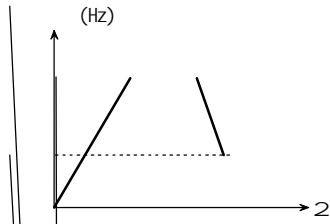

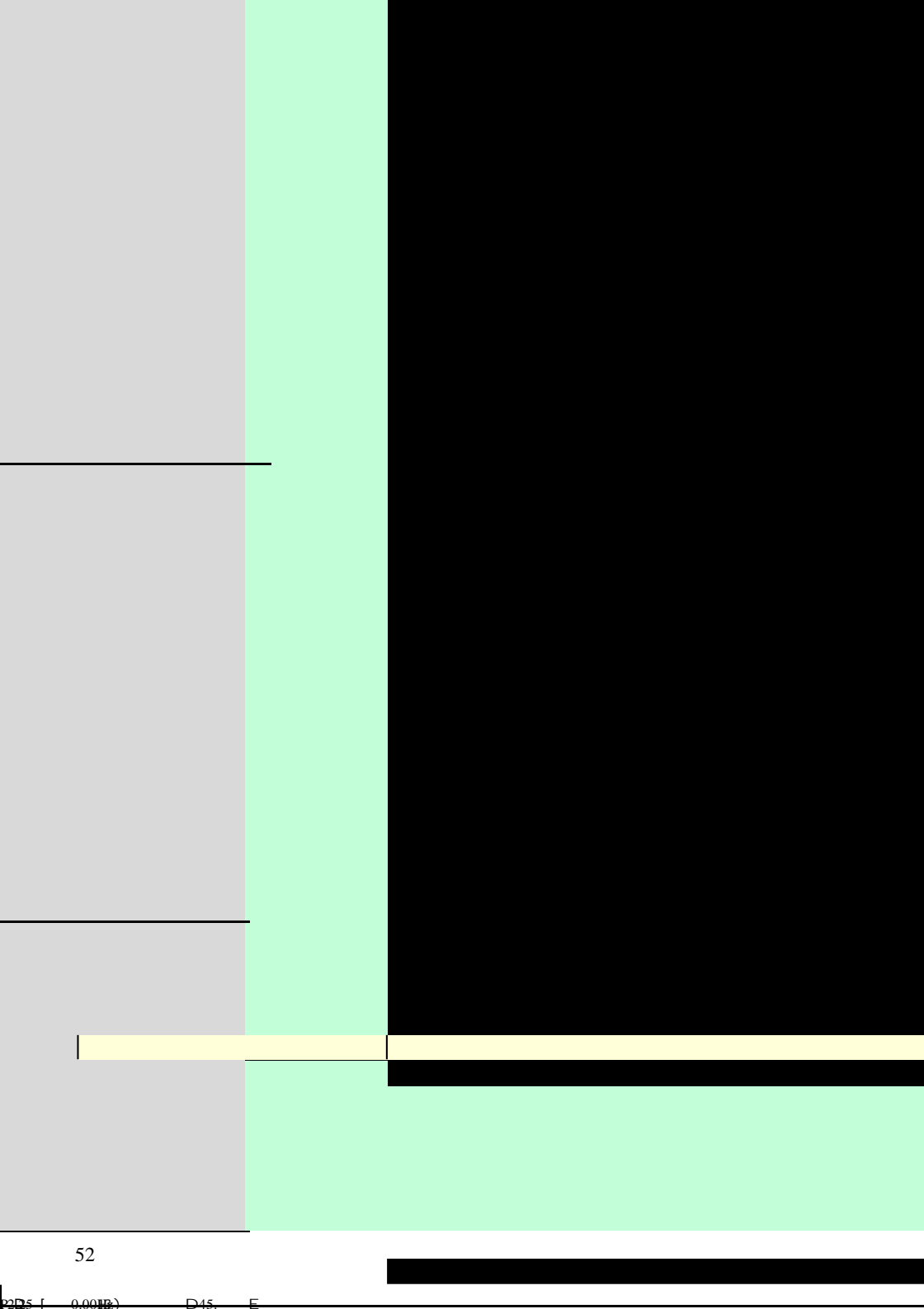

P2.28	2 2	\$ 0.1) 3600sD6.0/20.0sE
P2.29	2 2	\$ 0.1) 3600sD6.0/20.0sE
P2.30	2 3	\$ 0.1) 3600sD6.0/20.0sE
P2.31	2 3	\$ 0.1) 3600sD6.0/20.0sE
P2.32	2 4	\$ 0.1) 3600sD6.0/20.0sE
P2.33	2 4	\$ 0.1) 3600sD6.0/20.0sE
P2.34	2	\$ 0.1) 3600sD3.0/10.0sE

b7 2 2 3 4 . 2 1QP0.18 P0.19 . 2  
 Q j wx P3.01) P3.05 O + 2 1 \$wx \* j {  
 672 2 k 2 Fx 2 j wx  
 Q \$ P2.34 2 P1.10  
 \$ 2 n | . P2.35 2 q t \$ 2 T/ q 10q

P2.35	2 q	\$ 0) 2D0E
-------	-----	------------

0 1q 1 10q  
 2 0.1q  
 2 = 2 2 q

P2.36	YZ &[	\$ 0 1D0E
-------	-------	-----------

0 p 1 &[ 8  
 p &[ 8 3 bc O 50( &[ s +  
 30 bc  
 &[ 8 . &[ 8

P2.37		\$ 0 1D0E
-------	--	-----------

0 F 1 C 8T J 1

P2.38	C	\$ 0 1D0E
-------	---	-----------

0 ! " C 1 pC  
 \$\$ 1 pC  
 ^ \_ \$ C 2 0  
 wx RJOG C x  
 & wx C REVC wx 2

P2.44	PGV	\$ 1) 9999D1000E
-------	-----	------------------

P2.44 V \$

P2.47	PG R 2 ( j )	\$ 0.0) 10.0D2.0sE
-------	--------------	--------------------

P2.48	PG 2 ( j )	\$ 0) 3D1E
-------	------------	------------

0 1 Q  
 2 3  
 2 + P2.48 P2.47 . R 2 O 2 P2.47\$



P3.03 X3wx	\$ 0) 79D37E
P3.04 X4wx	\$ 0) 79,82D0E
P3.05 X5wx	\$ 0) 81D0E
P3.06 X6wx	\$ 0) 79D0E

wx X1) X6 wx \$ P3.01) P3.06 { & ! " .  
 wx { 8 2 \$ m5-3-1

5-3-1

&'		&'	
0	NULL	1	FWD
2	REV C	3	RUN
4	F/R	5	HLD #
6	RST	7	FC \$
8	FJOG x	9	RJOG C x
10	UP . W	11	DOWN -
12	UP/DOWN 0	13	FRE Q
14	* 2	15	
16	p	17	p
18	S1 1	19	S2 2
20	S3 3	21	S4 4
22	S5 5	23	S6 6
24	S7 7	25	& 9 v wx 2
26	SS1	27	SS2
28	SS3	29	SS4
30	T1 2 1	31	T2 2 2
32	T3 2 3	33	T4 2 4
34	TT1 2	35	TT2 2
36	*	37	EH0 j
38	EH1 j	39	EI0 j
40	EI1 j	41	
42	PLC s	43	PLC K
44	PLC	45	j
46	j	47	PIDs
48	/ 9	49	2
50	e	51	i
52	j	53	2
54) 73	j	74	wx
75 76	j	77	PID 0
78	PIDc b 2	79	& 9 v ^ _
80	PULSE	81	J J AJ
82	J BJ		

m5-3-1 <  
 0- wx wx R wx 3 gh. wxl mn  
 1) 5 P3.15 \$ pKL ~  
 6-RST ^ \_STOP/RESET^ \* 3 RST wx \*  
 T - - wx RSTZ { . Wvk (

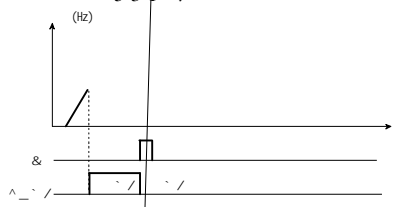

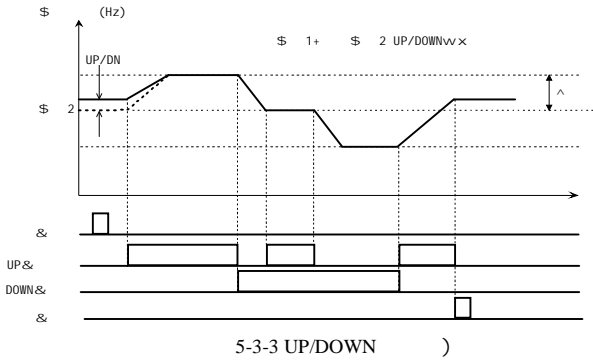

wx UP/DOWN I

P0.03=9 C 2

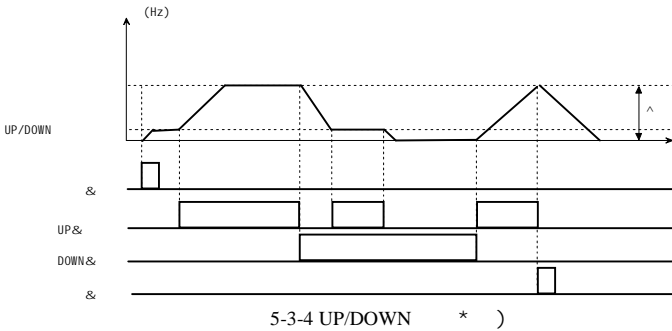

13-FRE	Q	.	wx	2	3	Xf	PWM	*	I	FRE
wq2	Z	O	.	j			P0.07	h		C
	P1.10									
14-	*		2	36-	*			2		P1.10
15-			wx			P		.		B
	m2		P1.11) P1.14			2	P1.15	2	wx	# 2
m		5-3-5 /								

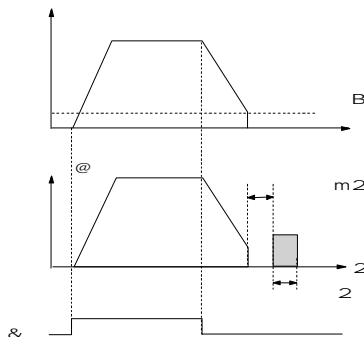

---

16- pZ # gh D 1. & . # \$  
17- p wx 2 + Q m i p  
18) 24 26) 29 2 / p ^\_ wxZ ) O O T  
i / F 1 3 7 . 4 4

EIO j      EII j      j      0      80  
 j /      x R      EH0 j      EHI j      J :      5-3-6

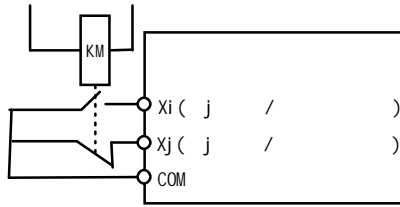

5-3-6 , / , -

41- wx P  
 42) 44 wx PLC  
 PLCs 2 t \$ 1 PLC PIDs } z \$ U22 PLCs  
 PLCK 2 K wx 2K 2 0 K Z ` x  
 wx O STOP ^ i 2 O  
 + 5  
 PLC PLC wx 2t . PLC 2 y t  
 2  
 47-PIDs PID t \$ 1 PID \$ U22 PIDs  
 48- / 9  
 QP8.10 \$ F wx \$P8.10  
 \$ 0 2 \$wx\$ 48 2 + 9  
 49 53 2  
 49 wx 2 22 B 2 2 0  
 \$ 2 P3.33 2 p 2 5-3-7 /  
 53 wx 2 P3.33 2 9 bc + |

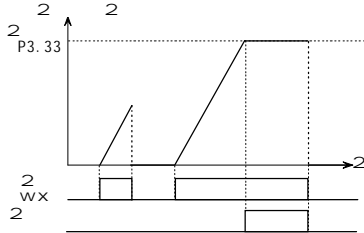

5-3-7 .

50- e 200Hz 2 y\$  
 51- i i e Q  
 74- wx wx 2 36 wx  
 77-PID 0 PID 2 \$wx\$ C 2 \$ PID 2 \$  
 wx\$ C 2 i  
 78-PIDc b 2 PID 8W PI \$wx\$ C 22t l ! cb  
 0  
 80-PULSE wx \$ :  
 P4 } |





/			O1
29	—`	l —` 2wx	
30	i	0 2wx	
31	j	j	
32	j	j	
33	1	\$ 9 2 3 E	
34	j	j	
35	u R ULP	\$ u 2 u R	
36		g 5 8 wx 18) 24 26) 29 wx	
37		74 wx 2 wx	

P3.26	R v	\$ 0.00)	10.00HzD2.50HzE
-------	-----	----------	-----------------

\$ 2 { R v \$ 0) 10.00Hz \$  
 \$ R v 2 J wx 5-3-8 /  
 (Hz)

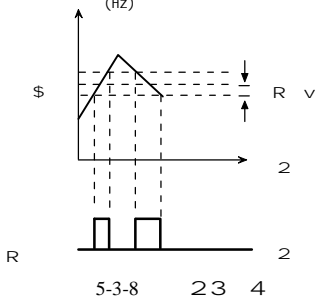

P3.27 FDT	\$ 0.00)	D50.00HzE
P3.28 FDTw	\$ 0.00)	10.00HzD1.00HzE

\$ 1 8 Z R 2 J wx F Z  
 FDT - / FDT J wx t Z /  
 5-3-9 / FDT 1 8 . } R Z FDTw

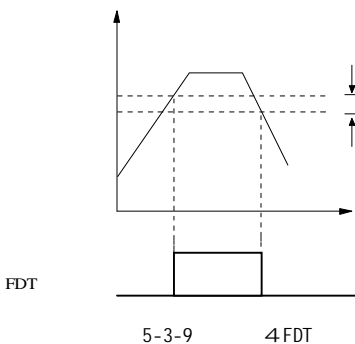

P3.29	wx " x 2	\$ 0.0)	100.0sD0.0sE
P3.30	wx " x 2	\$ 0.0)	100.0sD0.0sE

{ < P3.19) P3.25\$ D0 1 FDTw . FDTL  
 2 | 9 2 p k \$ 5-3-10 /

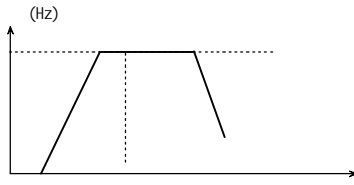

5.5            78            P4

P4.00											\$	0) 3D0E	
0											1	All	
2	AI2	S2R4GB	S2R75GB	j				3					
	\$ P4.00	\$	0 2	P4.01)	P4.05	\$	All	}	P4.11)	P4.15	\$	\$	
2 W	\$	3	C+	KL									
	P4.00	\$	0			2	P4.01)	P4.15	\$	P4.00	G	' (x	• 2
	G	•	1 W	G									
	\$ P4.00	\$	1	2(S2R4GB	S2R75GB	j	)2						
											G		

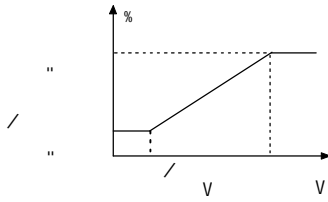

5-4-1

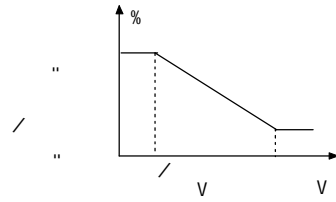

2 \$ P4.00 \$ 1 2(S2R4GB S2R75GB j ) 3 2 P4.01 P4.04 P4.06 P4.09 P4.11) P4.14  
 . ( 1 z \$ F J • . | \$ | x  
 5-4-2 / P4.01 P4.03 P4.06 P4.08 P4.11 P4.13 ,

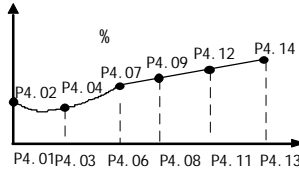

5-4-2

3 • 2 • 1 pKL 1.  
 • 2 U / 2 : { \$  
 " x 67 \$ \$

P4.21 AO1	\$ (0) 14D0E
P4.22 AO2	\$ (0) 14D0E
P4.24 DO	\$ (0) 14D0E

0 NULL 1 (0-2I<sub>N</sub>)  
 2 @() @) 3 PID (0) 10V  
 4 PID CJ (0) 10V 5 W• 5V  
 6 (0) 2 q 7 (0) 2 q  
 8 k @() 1000V 9 AI1 (0) 10V/0) 20mA  
 10 AI2 (0) 10V/0) 20mA (S2R4GB S2R75GB j ) 11 j  
 12 => (0) ) 13 => (0) )  
 14 \$ (0) 2 q @ DC 10V o Q  
 \* \$ 1 W Z -

P4.25 AO1	\$ 0 1D0E
0 0-10V	I 2-10V

P4.28 AO1 y	\$ -10.00) 10.00D1.00E
P4.29 AO2 y	\$ -10.00) 10.00D1.00E

\* F l m E ~ U W l m` / ~ U l m` /  
 AO1 y W O• W• \$ P4.21 5 DC5V  
 W 2 89 • P4.28 1 1 2 5V  
 { 50% D AO\* y W• AO1  
 2 P4.28 3 E n ^  
 l m m ~ U + . l m W

P4.31	A01 b	\$	-100%)	100%D0.0%E
P4.32	A02 b	\$	-100%)	100%D0.0%E

Ob Sb m/ y Sk m/ Sy m/ O• Sx m/ +  
y=kx 10b A01b 100% 10V O• Z 0) 10V 0) 8W  
i F ^ bU 3 gh l O o  
02 8V 2 3V + y \$ S-0.50 b \$ S80%

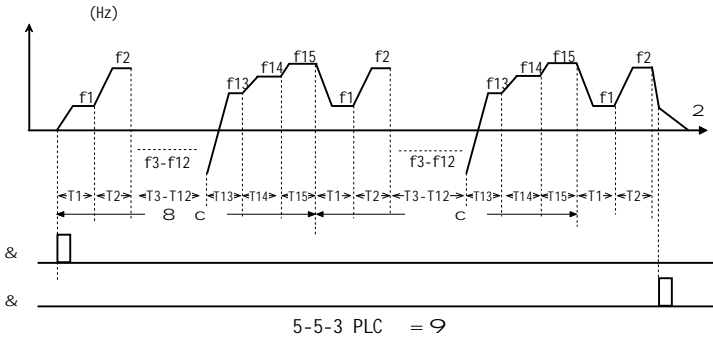

P5.01 PLC	\$ 0) 2D0E
0 8 B	1 2{ t
2 2{	
8 B	Q & 2 8 B
2{ t	
Q &	\$ t p 2 t
t	G2 5-5-4 /

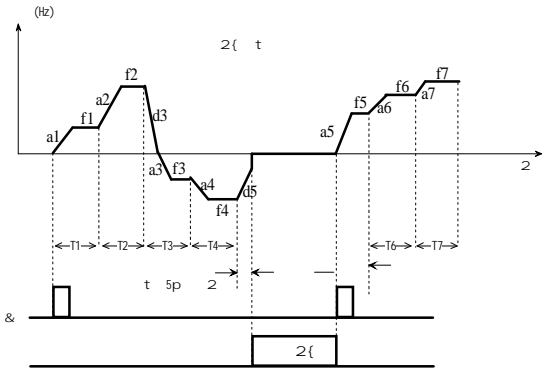

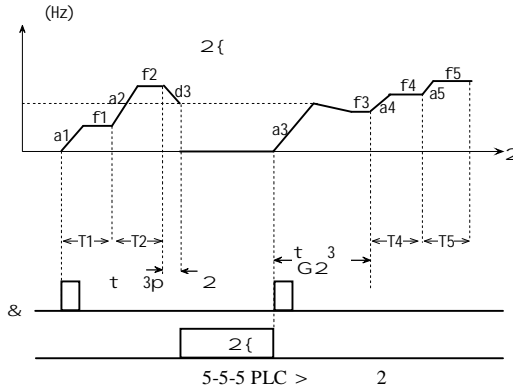

P5.02	2PLC	\$	0 1D0E
-------	------	----	--------

0

1

2 y PLC y PLC 2{ t p 2 z P5.01

PLC

P5.03	t 2	\$	0 1D0E
-------	-----	----	--------

0

1

l PLC t 2 PLC 2 :

P5.04	2T1	\$	0.1) 3600D10.0E
P5.05	2T2	\$	0.0) 3600D10.0E
P5.06	2T3	\$	0.0) 3600D10.0E
P5.07	2T4	\$	0.0) 3600D10.0E
P5.08	2T5	\$	0.0) 3600D10.0E
P5.09	2T6	\$	0.0) 3600D10.0E
P5.10	2T7	\$	0.0) 3600D10.0E
P5.11	2T8	\$	0.0) 3600D10.0E
P5.12	2T9	\$	0.0) 3600D10.0E
P5.13	2T10	\$	0.0) 3600D10.0E
P5.14	2T11	\$	0.0) 3600D10.0E
P5.15	2T12	\$	0.0) 3600D10.0E
P5.16	2T13	\$	0.0) 3600D10.0E
P5.17	2T14	\$	0.0) 3600D10.0E
P5.18	2T15	\$	0.0) 3600D10.0E

b \$ 2 \$ . 02 E 2 0.0) 3600 | P5.03 \$ b +

P5.19	T1	\$	\$ 1 F) 4 rD1FE
P5.20	T2	\$	\$ 1 F) 4 rD1FE
P5.21	T3	\$	\$ 1 F) 4 rD1FE
P5.22	T4	\$	\$ 1 F) 4 rD1FE
P5.23	T5	\$	\$ 1 F) 4 rD1FE
P5.24	T6	\$	\$ 1 F) 4 rD1FE
P5.25	T7	\$	\$ 1 F) 4 rD1FE
P5.26	T8	\$	\$ 1 F) 4 rD1FE
P5.27	T9	\$	\$ 1 F) 4 rD1FE

P5.28 T10	\$	\$	1 F) 4 rD1FE
P5.29 T11	\$	\$	1 F) 4 rD1FE
P5.30 T12	\$	\$	1 F) 4 rD1FE
P5.31 T13	\$	\$	1 F) 4 rD1FE
P5.32 T14	\$	\$	1 F) 4 rD1FE
P5.33 T15	\$	\$	1 F) 4 rD1FE

\* t 2 F v 8 { B m5-5-1

5-5-1 PLC ?

o		2	
1F			F
1r	2 1	P0.18 P0.19	r C
2F			F
2r	2 2	P2.28 P2.29	r C
3F			F
3r	2 3	P2.30 P2.31	r C
4F			F
4r	2 4	P2.32 P2.33	r C

P5.34	i	\$	0 1D0E
P5.35		\$	0) 15D0E
P5.36	2	\$	0.0) 3600D0.0E

P5.35 \$ PLC

2 P5.36 \$ PLC 2  
P5.34 12 P5.35 2 P5.36 0 R 0

& BC\*

t u m y PLC k A RA | > M ! P3" t u ( n 7 N

## 5.8 PID P7

P7.00 U1

P7.03 PIDCJ U1	\$ 0) 5D0E
P7.04 PIDCJ U2	\$ 0) 5D0E

0 PG J P7.03 / j P7.04  
 1 AIIwx 2 AI2wx (S2R4GB S2R75GB j )  
 3 j 4  
 5

P7.05 CJ	\$ 0) 5D0E
----------	------------

0 PIDCJ U1 1 PIDCJ U2  
 2 MIN PIDCJ U1 PIDCJ U2 3 MAX PIDCJ U1 PIDCJ U2  
 4 PIDCJ U1 PIDCJ U2 5 PIDCJ U1-PIDCJ U2  
 PIDCJ F G CJ G 02 PID { 2  
 ( ) { CJ G2 %P w%D(V)TjFl+57.

P7.22 ~Uo	\$ 0.0) 999.9D0.0E
-----------	--------------------

\* \$CJ F\$ U PID ~Uo \$ 2 PID K # \$  
5-7-1 /

\$ \$ ! F ~Uo -  
89 ( .  
PID2 ~Uo \$ P7.22 Q PID2-Uo \$ P7.22  
5-7-1 /

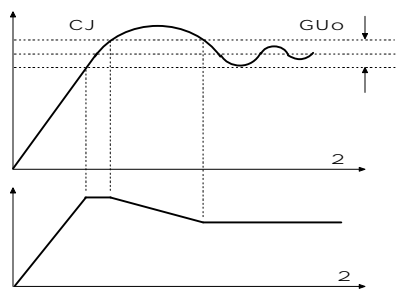

5-7-1 @A' #

P7.23 PID }	\$ 0 1D0E
-------------	-----------

0 1 C  
\$ PID 2  
C \$ PID / 2 Y

P7.24 cb	\$ 0 1D0E
----------	-----------

0 2 pcb 1 2 cb

& BC\*  
y r t O k ~ M 0M ) F & [ ] M k M N

P7.25 _`	\$ 0 1D0E
----------	-----------

0 1  
& BC\*  
2OPID] 4 ( nN

P7.26 _` 2	\$ 0) 999sD120sE
P7.27 _` a	\$ 0.00Hz) . D20.00HzE
P7.28 ~· a	\$ 0.0) 100%D80%E

i 2 p C ! C F 67 C S\_  
` a " 2E  
" 2 : a + C s\$ | S\_  
9 v ~· @ CJ (T-vS~· a 2 CE / 5-7-2 ~· a \$  
PIDCJ b!  
^\_ . 12 @ \$ t PC PC.01-PC.20 PC.16,PC.17 \$ 1 { G\$ 0  
` / 12 @ \$ i 12 L SENTER n  
M n @ :

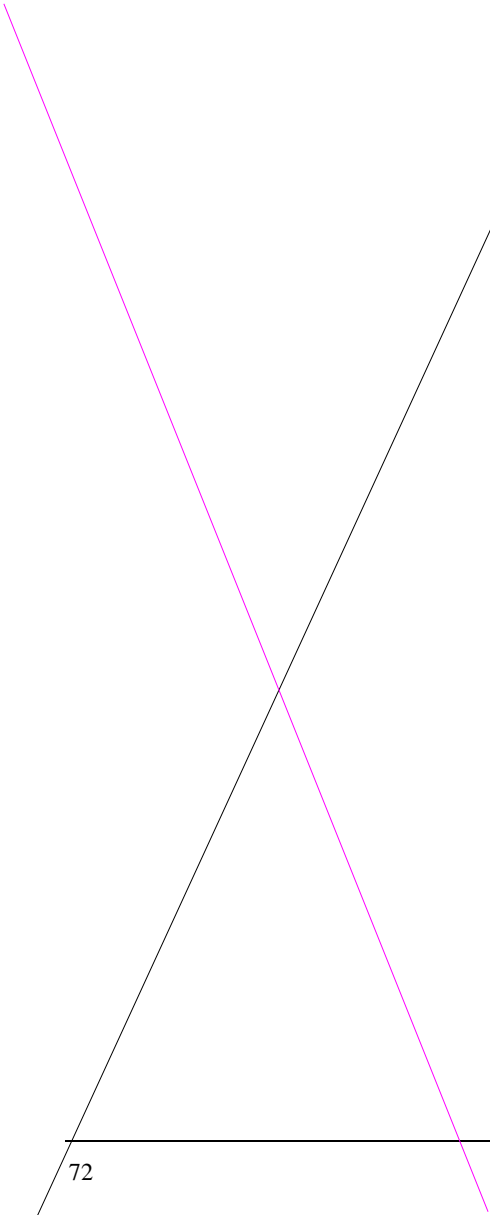



P8.14	\$ =>	\$	0.0%) 200.0%D102.4%E
		Z	=> 45

P8.15	2	\$	0.00) 120.0sD0.50sE
P8.16	2	\$	0.00) 120.0sD0.50sE
\$	2	2	2
0	2	2	0 2 2

P8.17	" U=>	\$	50.0%) 200.0%D117.0%E
		2	O 2= \$

P8.18	" U=>	\$	50.0%) 200.0%D117.0%E
		2	D \$ = 2 b +

C + /

P8.23	i W	\$	0.0) 50.0%D0.0%E
P8.24	i a	\$	0) 20%D5%E

P8.23i W => i 2 i 2 # 8  
i a \$ 0) 20%

P8.25	\$ U	\$	0) 5D0E
0	P8.11	z	\$ 8T 1 AII
2	A12 (S2R4GB S2R75GB j )		3 j
4			5

P8.26	=> y	\$	40.0%) 160.0%D100.0%E
P8.27	=> y	\$	0 1 2D0E

0 => 1 => j  
2 j

gn c Dc => => j b E

gn # ' 100.0% \$=>y S => 2 =  
P8.26\$ : 5-8-2

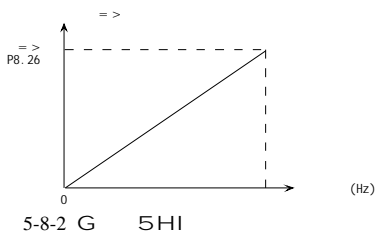

7

P8.28	i f J 2	\$	0.05) 1> 7
-------	---------	----	------------

# 5.10 V/F P9

P9.00 V/FI \$	\$ 0) 4D0E
0 9 #}   0	1 - }   1 2.0
2 - }   2 1.5	3 - }   3 1.2
P9.01 V/F F1	\$ 0.0) P9.03D10.00HzE
P9.02 V/F @ V1	\$ 0) 100.0%D20.0%E
P9.03 V/F F2	\$ P9.01) P9.05D25.00HzE
P9.04 V/F @ V2	\$ 0) 100.0%D50.0%E
P9.05 V/F F3	\$ P9.03) P0.09D40.00HzE
P9.06 V/F @ V3	\$ 0) 100.0%D80.0%E

V/F\$ z }

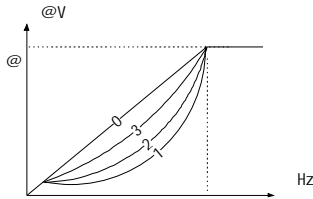

5-9-1 J 5

\$P9.00 42 P9.01) P9.06 V/FI 5-9-2 / x V/F  
 | } Q } 45 V1<V2<V3 2 @\$ , v

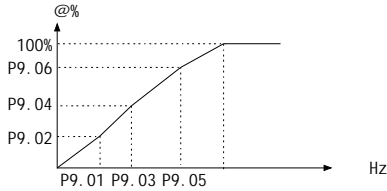

5-9-2 KL V/F MNO

P9.07 W	\$ 0.0) 30.0%D75kw 0.0% 93kw 0.1%E
---------	------------------------------------

=> } @ 8J W=> \$ 0.0% 2 J \$  
 02 W 5-9-3

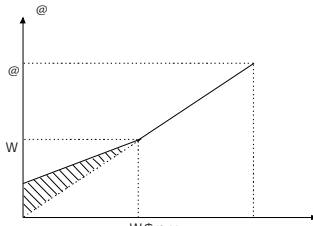

5-9-3 P 5QR

---

& BC\*

1pa I qLm23&' KN  
2p ? &' ] M , ` , ? 23B\Md &' v ` , v M V/Fe \ N

P9.08	W\$px	\$	0.00) 50.00HzD16.67 HzE
-------	-------	----	-------------------------



PA.01	1		\$	2) 56D4E	
PA.02	1		\$	0.4) 999.9kWDy	E
PA.03	1		\$	0) 24000r/minDy	E
PA.04	1		\$	0.1) 999.9ADy	E

PA. 01) PA. 04 \$ E 1 ' ( z \$

J :

s QQ 8WI ! " ! / { s 8s

PA.05	1	I0	\$	0.1) 999.9ADy	E
PA.06	1 x	R1	\$	0.001) 65.00 Dy	E
PA.07	1 x	L1	\$	0.1) 2000mHDy	E
PA.08	1 x	R2	\$	0.001) 65.00 Dy	E
PA.09	1+	Lm	\$	0.1) 2000mHDy	E
PA.10	1J ,	F 1	\$	0.0%) 100.0%Dy	E
PA.11	1J ,	F 2	\$	0.0%) 100.0%Dy	E
PA.12	1J ,	F 3	\$	0.0%) 100.0%Dy	E
PA.13	1J ,	F 4	\$	0.0%) 100.0%Dy	E
PA.14	1J ,	F 5	\$	0.0%) 100.0%Dy	E

z PA. 29 p O J PA. 05) PA. 09  
J , F 2E \$ \$

PA.15	2		\$	2) 56D4E	
PA.16	2		\$	0.4) 999.9kWDy	E
PA.17	2		\$	0) 24000r/minDy	E
PA.18	2		\$	0.1) 999.9ADy	E
PA.19	2	I0	\$	0.1) 999.9ADy	E
PA.20	2 x	R1	\$	0.001) 65.00 Dy	E
PA.21	2 x	L1	\$	0.1) 2000mHDy	E
PA.22	2 x	R2	\$	0.001) 65.00 Dy	E
PA.23	2+	Lm	\$	0.1) 2000mHDy	E
PA.24	2J ,	F 1	\$	0.0%) 100.0%Dy	E
PA.25	2J ,	F 2	\$	0.0%) 100.0%Dy	E
PA.26	2J ,	F 3	\$	0.0%) 100.0%Dy	E
PA.27	2J ,	F 4	\$	0.0%) 100.0%Dy	E
PA.28	2J ,	F 5	\$	0.0%) 100.0%Dy	E

2 \$ z 1 \$ PA. 00 1 \$ E

PA.29	S2R4GBF S2R75GB j	\$	0) 2D0E	
-------	-------------------	----	---------	--

0 1 p

2 1

0

1 p F 1 \$ RUN

t mPA.06) PA.08 / PA.20) PA.22 PA.05 PA.09 / PA.19 PA.23 z O•

\$

2 1 1 2 (TF

\$ RUN

& BC\*

1p 7 M ^ QR | &' ~ PA.01 PA.04PA.15 PA.18D

2p 82 7] ks &' , . / M = . / 7N

3p 7 7 &' k Mwx qn ' N

4p 7 ' D < PA.29 ? I 0N  
 5p 7 M } C - At- Ml 7 q { ( M } s C AtE N  
 4 p 2 F + ( { L I<sub>0</sub>  
 L<sub>m</sub> + h I U @ f

$$I_0 = I \cdot \sqrt{1-h^2} + I_m = \frac{U}{2\sqrt{3}pf \cdot I_0} - L$$

& B . 5-10-1 /

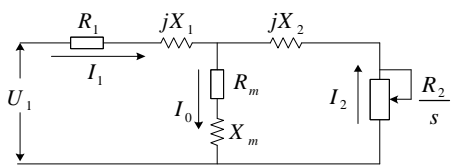

5-10-1 VW X Y Z

5-10-1 R<sub>1</sub> X<sub>1</sub> R<sub>2</sub> X<sub>2</sub> X<sub>m</sub> I<sub>0</sub> b 7 \$ m x x x x +

## 5.12 MODBUS Pb

8 PLC F 1-31 | MODBUS 5F PLC MODBUS Q  
 F E 2 Bz 2 E  
 8 F 8 | E 2 E D Z k { 6  
 /  
 \* RS-485 z @ @  
 2 • } 1200 2400 4800 9600 19200 38400 Pb.00  
 RTU # 8 p 1  
 ASCII # 7 8 p WX 2 1 WX 2 2 Pb.02  
 WX WX/ WX/ WX Pb.02  
 5 z MODBUS RS-485 | 31 |  
 / \$ n B Z o o o

Pb.00 • }	\$ 0) 5D3E
0 1200 bps	1 2400 bps
3 9600 bps	5 38400 bps

Pb.01 -	\$ 0) 31D1E
\$ - F z 8 2 . {   E \$ -	

Pb.02	\$ 0) 8D0E
0 1-8-1-E RTU	1 1-8-1-O RTU
2 1-8-1-N RTU	3 1-7-1-E ASCII
4 1-7-1-O ASCII	5 1-7-2-N ASCII
6 1-8-1-E ASCII	7 1-8-1-O ASCII
8 1-8-2-N ASCII	

Pb.03 2R 2 \$ 0) 100.0sD0.0sE

0 8 2R  
0 2R V Pb.03 \$ R O j  
EF0

& BC\*

] Y d F ' Mq M

Pb.04 " x 2 \$ 0) 500msD5msE

m\$ " x 2 O /

Pb.06 Eeprom \$ 0 1D0E

0 Eeprom 1 Eeprom

\$ 2 s Eeprom \$ 12 V  
t Eeprom \$ 02 + Eeprom O  
MODBUS - K - 0x00FF t o EEPROM J \$ ^ \_ ENTER  
 Eeprom e F Eeprom 8 F? n 1 i Fv F 5  
RAM 8 F I 45 Pb.06 0 Z

Pb.07 CCF6 I \$ 0 1D0E

0 k 1 Q  
\$ 2 s ` / \$ 12 O E ` / z 2  
.\$ 02 ` /

Pb.08 / \$ 0 1D0E

0 / 1 OZ /  
\$ 12 OZ 0x06 0x10 Z I )) (027432

1	0.01Hz	0.1Hz	1Hz	:	6	P0.17
PC.05	r/min			\$	0	1D1E
PC.06	\$ r/min. /			\$	0	1D0E

0 \ / 1 \ /  
 PC.05 \$ 1 \ / r/min O\$ 0 + \$ \ / >0 /F2

PC.19 wx \$

0 \ /  
PC.19 \$ 1 + \ / W  
wx Z #] Dm wx LED

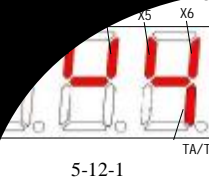

PC.21 \$ 1) 20

PC.21 \$ Y \ / 1) 20 b 7 PC.01) PC.20  
\$ \$ \ / \$ \$ / 20 26 1  
S v \ /  
Y \ / 20 Y 2 CALL \ /  
2 b Y s

PC.22 \$ 0.1) 9

PC.22 W { \ / E 8 1.  
=  
=120  
\$ =PID \$  
\$ =120 \$

PC.23

PC.23 W  
= PC.23 PG  
\$ =\$ PC.23 PG  
& BC\*  
C~ \*  
Oj V 7 0.000) 65.53m/s QS ( 999.9kW  
QS 2 3 0) 300.0% QS 8 999.9V  
 \ & 8 0) 1000V All 0) 10.00V  
XY 6 0) 65530

5.14 ; [ \ ] Pd

2 a 3 Pd.02 Pd.04\$ 2 G Pd.01 Pd.03\$ 1F

Pd.01	1	a		\$ 0.0)	10.0VD10.0VE
Pd.02	1	2	G	\$ 0)	4D0E
Pd.03	2	a		\$ 0.0)	10.0VD10.0VE
Pd.04	2	2	G	\$ 0)	4D0E

0 wx All 1 A12(S2R4GB S2R75GB j )  
 2 j 3  
 4 \$

Pd.05	x,			\$ 20)	110%D100%E
-------	----	--	--	--------	------------

P - z ! "

5-13-1 /

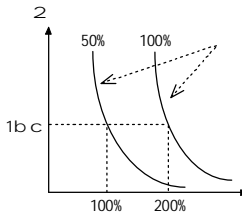

5-13-1 ^ \_ ; [

! " = \_\_\_\_\_ U100%

Q  
 { ! " 8W  
 , ! m 2 G. 8J ( 10% ) , mU2 / 8J

& BC\*

L & ' ~ 67&K6, ~ 67&Kq %] M 7Pd.05~ 6m y & ' ~ R@N N  
 N ? ] PWMMd\* OLI N

Pd.06	i	R		\$ 20.0)	200.0%D160.0%E
Pd.07	i	R 2		\$ 0.0)	60.0sD60.0sE

i R Pd.06 . i { \$ J

& BC\*

1p /b 警 S水OA Y] d~ I 般kN证b 警 /N ? N  
 2p /b 警 S] dFM 工 &K1 /b 警 S水OMx' F~ /b 警 S] d  
 0N

Pd.08	^	\$	0) 3D1E
0		1	9
2		3	2-

Pd.09	^	\$	G 30) 180%D160%E P 60) 140%D120%E
-------	---	----	-----------------------------------

2 Q 2 U Q L . W  
 Pd.08 1 2 32  
 \$ 1 2 2 \$ ^ Pd.092 p L  
 R 2 z Pd.09 t z 2 4D-  
 \$ - OPd.08 2 R bD OPd.08 1 Pd.09 # Pd.20\$ 2 t z  
 OPd.08 3 ^ Pd.09 # Pd.20\$ 2 t z  
 2 4D \$ - R bD  
 # l ^ lmin . + OL2 Q 2  
 STOP/RESET ^ V 2 / 2s OL2 Q

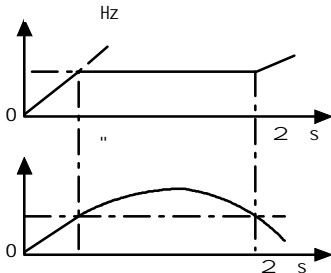

5-13-3 ^

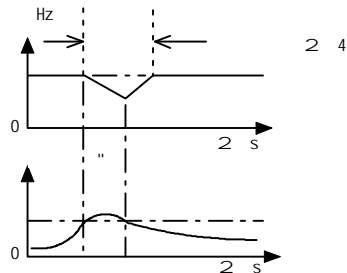

5-13-4 X ^

Pd.10	@	\$	0 1D1E
-------	---	----	--------

0 p 2 4 5 1 ! "

Pd.11	@x	\$	110.0) 150.0%k @ J 220V 120% J 380 140%E
-------	----	----	--

! " k @ ~ @U1.14 220V Pd.11 n 120% e 373V 380V  
 Pd.11 n 140% e 752V  
 n @x 3F : 380V n @! @ x 52V  
 n x 700V 220V 23V n x 350V  
 - 2 l J k @W J P  
 + @  
 O Pd.10=1 + 2 k @W 8 ( Pd.11) 2 K #  
 k @- O M B  
 # l @ lmin . + Ou @ Q STOP/RESET ^ 2  
 STOP/RESET ^ V 2 / 2s @ Q

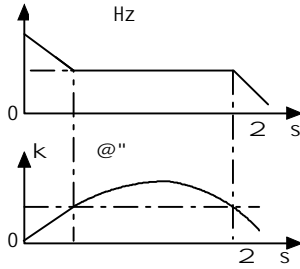

5-13-5 ^

Pd.12	6J R •	\$	1) 100%D100%E
Pd.13	6J R 2	\$	2) 255sD10sE

R • Pd.12 R 2 Pd.13.C + / R • Pd.12 R 2 Pd.13 \$

Pd.14	6J R • S2R4GBF S2R75GB	\$	0) 100%D1%E
Pd.15	6J R 2 S2R4GBF S2R75GB	\$	0.0) 20.0sD2.0sE

\$ / R • R 2 .C R • / R 2 F ; 6J

Pd.17	AE1 AE2(S2R4GB S2R75GB j )	\$	0 1D0E
-------	----------------------------	----	--------

0 \ / 1 \ /  
: \$ 2 s \ / , \$ 12 C 1/2 \ / AE1/AE2 ,  
\$ 0.2 \ / ,

Pd.18		\$	0) 10D0E
Pd.19	2	\$	2.0) 20.0sD5.0sE
Pd.20	n2	\$	0) 200msD50msE

OC Ou GFF

\$ Pd.18F 2 Pd.19 Xf  
Pd.18\$ 0 2m/ 3

& BC\*

谨慎` , ? KH( nMwx mn 引j 人身伤害v 财物 • J N  
SC 10SU n ? KHN

Pd.21	2	\$	0 1D0E
-------	---	----	--------

0 1

Pd.22	& 9	\$	0 1D0E
-------	-----	----	--------

0 1 M & M  
\$Pd.21\$ 12 . & 67 . t .  
& O  
\$Pd.22\$ 12 \$ 1 2 & 9 t 3  
M & O \$ 1 2 & 9 t M  
& O

Pd.33	k	x	S2R4GB F S2R75GB	j	\$	100.0%) 300.0%Dy	E
Pd.34	8k		S2R4GB F S2R75GB	j	\$	0 1D1E	

0 p 1 ! "

k x 100.0% Pd.33\$ 300.0% 2 Pd.33  
 8k x 230.0%e & :  
 8k ! k C : 45 g8k

Pd.35	8k	6J R	3030G/3037P	j	\$	0 1D0E
-------	----	------	-------------	---	----	--------

0 p 1 ! "

a 7 Pd.12 k 6J R 8k 6J R \$\$ 02 p 12! " R

## 5.15 bcde PE

PE.00	/				\$	0) MIN(p 30)D1E
PE.01	}				\$	m 5-14-1DNULLE
PE.02	2				\$	0.00Hz) . D0.00HzE
PE.03	2\$				\$	0.00Hz) . D0.00HzE
PE.04	2				\$	0) 2q D0.0AE
PE.05	2k	@			\$	0) 1000VD0VE
PE.06	2	7			\$	0) 3DStPE

0 StP 1 Acc

2 dEc 3 con

PE.07	2=	2			\$	0) 65530hD0E
PE.08	2IGBT				\$	0.0) 200.0( D0.0( E

2 E 2 7 B \$ + 3 Xf PWM Z / [ TRIP. / z  
 E 30 \$ PE.00D PE.01-PE.08` / 8 0  
 m/ ` / 1m/ 8 E 2` / NULL c m/ c  
 PE.00 p } m5-14-1  
 5-14-1 \ ]

NULL		Uu1	k u@
Uu2	Wu @	Uu3	Y W '
OC1		OC2	
OC3	9	Ou1	@
Ou2	@	Ou3	9 @
GF		OH1	+, ,
OL1		OL2	
SC	W	EFO	D j
EF1	wx. j	SP1	6J 9
SPO	6J 9	CCF1	W 1 5  ^_ 2 : 43
CCF2	W 2 ^_ 2 2  .	CCF3	EEPROM
CCF4	AD	CCF5	RAM
CCF6	CPU KL	PCE	o ~
HE	; < R	DE	R
CUE			

PE.10	=	2 h			\$	0) 65530hD0E
-------	---	-----	--	--	----	--------------

PE.11 =	2 h	\$	0) 65530hD0E
PE.12 =	(MWh)	\$	0) 9999MWhD0E
PE.13 =	(KWh)	\$	0) 999KWhD0E

= 2 (h) 1 2  
 = 2 (h) 2 =  
 = (MWh) =  
 = (KWh) =

PE.14 IGBT	IGBT	\$	0.0) 200.0( D0.0( E
------------	------	----	---------------------

PE.15 >	>	\$	0.0) 200.0( D0.0( E
---------	---	----	---------------------

### 5.16 ; [ PF

PF.00 ?	?	\$	0) 9999D0E
---------	---	----	------------

? \$ ? B\$ 0 m/ ? \$ 2 PF \$ F  
 \$ o  
 ? f \$ ? \$ E PF 2 \$ ? f s+t  
 PF  
 ? O ? E + ? f PF.00 M  
 ! " E O ENTER ? \$ PF.01 0 j

### & BC\*

, 7f, 密T < MB PRG/ESC : 退S PF " M 7~密T > ? @N  
 , 7, 密T < M ^ \_ 字 7~, 密T Mwx s q n 访问本" F R N  
 , 忘 7~密T M 联 厂家N  
 ? C 例\*s, 密T 7 1234M E S PF " < M y, 密T 解 N l 图 5-15-1 v 图 5-15-2)

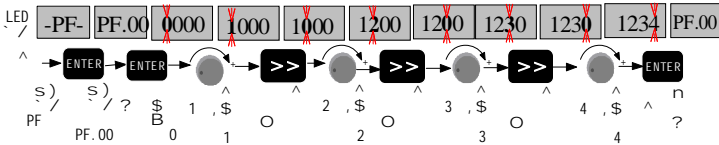

5-15-1 K L f

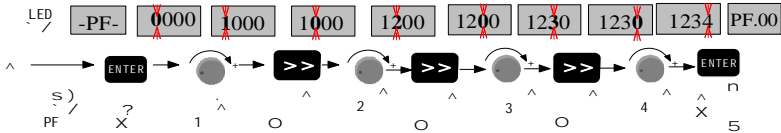

5-15-2 K L f g h

PF.01 O	O	\$	0) 2D0E
---------	---	----	---------

0 j ! " E O  
 1 . \$ P0.0 F { | p O  
 2 . j p O

PF01 \$ 0 j ! " E O l m O F p2 O O  
 l p2 O { | + O : F p2 s 4 SF ^  
 \_ \ / O . / / + m / ! " O O . / \ / + ! " O  
 PF01 \$ 1 . \$ P0.02 F { | p O  
 PF01 \$ 2 . j p O

& BC\*

， 监视 MPF.01 7 0全Y 允许；写Mxm \M dND 7 )AOj PID  
 给7vOP PID 7给7NL PF01 7 1] M n \M dND 7 )NL PF01 7 2] M  
 R \M 4@N

PF.02	BL	\$	0) 3D0E
0			1 .
2 R	\$ ( \? \ . )		3 R \$ ( \? . )

PF.02 \$ 0  
 PF.02 \$ 1 t . PE PE.00 PE.08 b  
 PF.02 \$ 2 tR \$ ( ? \$ F . )  
 PF.02 \$ 3 tR \$ ( F ? \$ . )

& BC\*

， 忘 7|又q想 修; Mxm` , PF.02 7 2~ ( nMt O核KS厂6M  
 便重新 7 N  
 除历史 录 恢KS厂 76< MPF.02 ?恢K 0MJ Cyk~ 已经完{ N

PF.03	@A	\$	0) 3D0E
0			1 j
2			3 B

1- j ^ \_ . \$ t @A  
 2- . \$ t @A ^ \_ .  
 3- t ^ \_ . \$ @A  
 \$ PF.03 ! " ^ \_ \$ PF.03 @A @A  
 ^ \_ \$ PF.03 @A ^ \_ / @A @A PF.03 R 0 ^ \_ / @A 2 STOP  
 ^ R ^ \_ \ / O X Eeprom + CCF3  
 @A / B .

	B .		B .		B .
dn0	j	dn1	B	uP	.
SUCC	@A	StP	^ _ Stop ^	rEt	
EFLF	BT	bdAF	^ _ .	rEF	
UrO	X 2	brtO	^ _ 2	LdtO	@A 2

& BC\*

种工X&M ` , %( nMmt O拷贝, 7f ~ Mf 少M试维 ~ ] dN  
 拷贝( n y 拷贝: 盘 %件DR@M\* 允许 ! A ' - ~ d 拷贝  
 6000M-S2R4GBA S2R75GB 软件版本 V110 M6000M S21R5GBA S22R2GBA 6000E ! 软件版  
 本 V140 版本 c 拷贝N

PF.04 G/P	\$	0 1D0E
0 G 9		1 P & C)

\$ G/P 8 s + Bz 0 PF.02 BL 2  
 \$ G P t \$ 1  
 O 2 5.5kW G 7.5kW P \$ PF.04=1

& BC\*

理Ma ( nT P- ; G- ] M 15 似N

PF.09		\$ 0) 9999Dy	E
PF.10	k	\$ 0.00) 99.99Dy	E
PF.11	O F	\$ 0.000) 9.999Dy	E
PF.12	k 7	\$ 0) 9999Dy	E

[ ]

# 6.1 V, i j k

82 R 8 2 ^ \_ . \ / z 2Xf PWM  
 4 / [ STRIP . / x Q 2TRS b F P ( )  
 RS I GG 0804 - 8. 4 TDF ( I ) Tj / F6 6. 48 Tf 4. MS O TDS ( ) / Tj / F6 + 1 6.  
 j wx 45 I \$ wx 0804 + 8. 4 TD ( I ) Tj / F6 6. 48 Tf 4. 8 0 TD ( ) Tj / F6 + 1 6. 48 Tf 9. 36 0 TDSH ( ) Tj / F6 + 1 6.  
 O 3 W U8 0804 8. 4 TD ( I ) Tj / F6 6. 48 Tf 4. 8 0 TD ( ) Tj / F6 + 1 6.  
 10s O! " \ / O SF E2 7 \$ I 2 8  
 k @ E o S /\* ^ G8883 0804 (+) S j / F4 6. TD  
 2 \$ PE. 00) PE. 08 S 5 1 8G

6-1 V, i j k

\ ]	; [	\ ] I m	n
-----	-----	---------	---

UuI k u@ I @ I RS U @  
 I RSR \$

2 @

RS22RSR

I GG

I G. 2

I 2 28

@RS22RSR

I RS G2

G

UuI \$ G

I GG

\$ 288

2 G 2

\ ]	; [	\ ]   m	n
OL2		   W/FI   @     2 b   ^	/ " # 2   / " # 2   V/FI F W   RS @     2   ^
SC	W/ W	W   W	RS F s   RS   RS
EF0	D RS485 j	MODBUS 2 o~   j W E	\$ 2R 2 t Pb.03 2   R 2 \$ 0.0s   RS j W   RS wx 67 wx   : ^ / R

6.3

\ ] k

E g8 RS{ b J P FJRSF P

6-3 \ ] k

\ ]	&'	k
	U @ s Uwx R S T. CHARGE LEDZ/[ #s	I U I U I RS U @ I nwx p K
	s @m wx U V W @	I U
	O sE f	I 4 Fa. f
	^_ / RSTRIP[ s. /	I \$ S m6-1
	s Z	I RS wx s
	C \$ s Z	I \$ ! " C Z
	wx s	I wx
	@ s	I RS @
	\$ s	I \$
C J	wxU V W s	I U V W I P2.45
1	W s	I
	s	I 4 " # 2
	\$ s	I RS \$
b b	@mRS wx @- s	I RS V/F }
	s	I 4
	s	I 4
	J U 6J	I RS J U 6J I J U AC v U
	U	I RS U
ZP	= v ' xb	I
	. b	I .
( b	v(	I \
		I
	J 9	I RS

[ ]

7.1 o p q

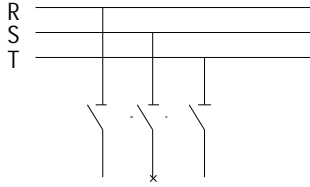

N :

W

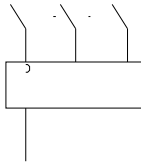

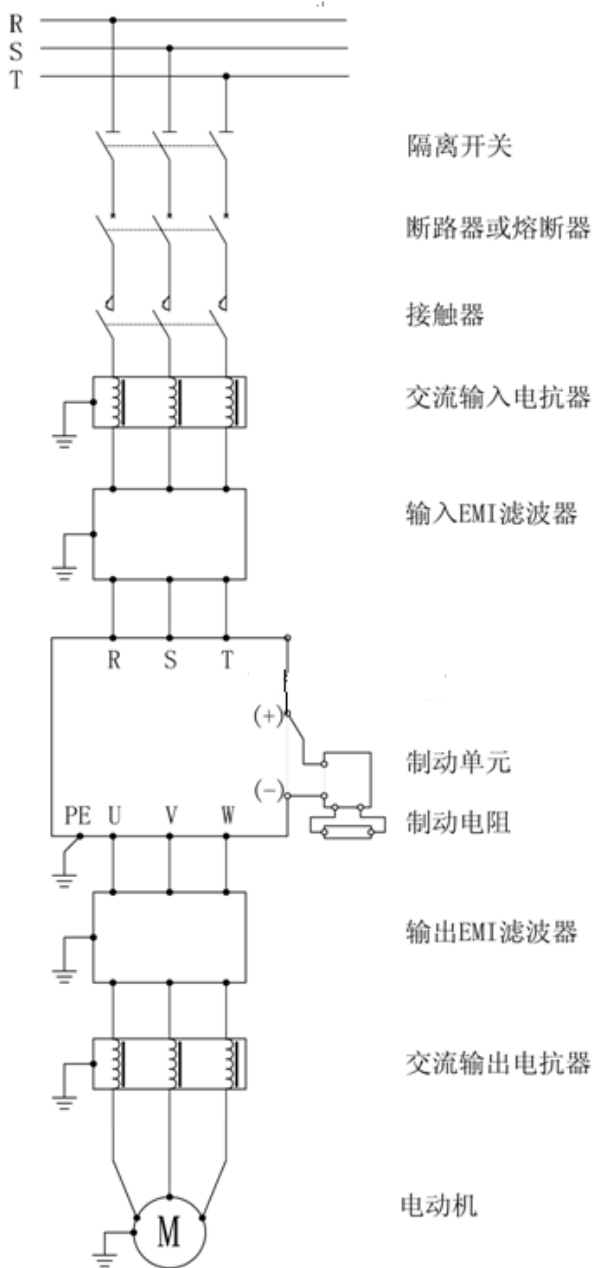

- 隔离开关
- 断路器或熔断器
- 接触器
- 交流输入电抗器
- 输入EMI滤波器
- 制动单元
- 制动电阻
- 输出EMI滤波器
- 交流输出电抗器
- 电动机

7-2 3018G/3022P ○ p

## 7.2 o p

### 7-1 o p K

o q	j	r	*S t 2 %0.9 rg .81 1 0 -rg h %EM 0.2 2 T +4 7 (-) Tj 201D %0 Tc (Pb) 8 TD (8) Q q 4 Tt 0.85 1 0 -0751 @ 67.112	=Pb / E KL N/ 20 2 45 U Q N 2 2	* W X 2 U :
	: 9 p { W T U	29 U p	- • * U		

4 =\* g k

### 7.2.1 s t

u \* . 45 67

u

I Uo o ! 10 1 .

I z 8 U. = : P b = >

I J U @ 9 m e 3%

### 7.2.2 w x

15kw n 2 18.5kwv 93kw

Q 110kw .

B j b j b q + @ q

j b , 45{ x v W

8W 10% z m

@ 2

7-2 51 0-.0751@ '18 TD (8) 4 Tt 0.85 1 0 -0751 @ '18 080 TD (8) Tj /24 Tt 0.851 0-.0751 @ %

2 E j gn . ,  
U U R = Pb

R U 2 @ z 8 380VAC

8W 700V 220VAC 8W 350V Pb j . F 8T 8W

d- 70%

0.7 Pr = Pb D

\$

---

Pr

D

E

!



m

7-3

y

F 7

[ ] ,

 " #	
1. def wx wx. @ e >?	
2. ' ( wx \ \2 8 U e >?	
3. 9 W U nCHARGE LEDZ/[ \] RS	
o. G @ >?	
4. K L d RS e >?	
 ' (	
1 ^_X WX WX. CMOS W 2 } 745 Z e	
f WX WX.	
2 d wx e >?	
3. dRS \$	

8.1 ; { | [

Q x E x J2 ~ & \$ E x }  
 x L . 1. j k L %  
 T E # RSF  
 3 6 8 ! b(

8.1.1 } , | [

2 n ; <  
 | s P ( s ,  
 | s  
 | m s 8  
 | YZ&[ s  
 | s  
 RS o m&l /  
 8-1 } , | [ &'

	RS<	RSj	RS; <	O•
1	^ /	LED	^ / s	RS / s
2	YZ	&[	s s P sc@	
3			W . c@	
4			. ?@ H	2.2 *
5	@	wx	@	z 2 *
6			W . (	

8.1.2 ~ | [

RS2 8 9 U m \ / W UZ/[ \ ] 5) 10 bc  
 O RS 9 o j @G L  
 RS o m 8-2 /

8-2 ~ | [ &'

RS<	RS o	
Wwx Ww	s	K
x	s ?@	4) 6kg/cm <sup>2</sup> @ K @T
+,	s ?@	4) 6kg/cm <sup>2</sup> @ K @T
PCB V WX	s ?@	4) 6kg/cm <sup>2</sup> @ K @T
YZ&[	( s s P s c@	YZ&[ . c@F
k	s ?@	4) 6kg/cm <sup>2</sup> @ K @T
o	s >	o
	s'	t q K

RS 5 k k 5P k s+ T  
 \ / v T k : k IGBT { | k  
 2 45 z l m U7m 2 @m  
 @ > @m @ m } m k &  
 2 z 8 m ! m  
 • } 45 ' 40MHz /• j • } 2+ 100MHz  
 /• (T N  
 U J 92 45 }  
 Q p X X a } X CF} XV  
 8 - @ \$ } X v k } X  
 45QM L  
 O W @ X (T 2 \$ o J\$ @I Xt- %&  
 W X (Tt Wwx R S T U V W PB(P1) + - j W @  
 sJ m 220V s 250V 380V s 500V 660V s 1000V W  
 m  
 380Vs W / 5M W / 3M

8.1.3 ~

# (T- j x k %& F  
 x k %&x { F k z z 8W 2 m \*  
 ' 67 & 67  
 m 8-3 / 2  
 8-3 •

k	O•
YZ&[	2) 3
o	4) 5
V WX	5) 8

8.2 ; [

3 K2 # 2  
 I q \* C ?@ @ &  
 I 8 : + Y X W o } R Y 2  
 @ ; ; W @ v @ 2 1) 2 / 2 .  
 I ( Xv4V 8  
 5 P @ X | t T %&- v k X 500V  
 m X { / 4M

---

[ ] ,  
) 8 , < N  
Z B  
! 24  
Q ( b 3 >  
I ! "  
I O • \*  
I  
I A k L  
I j  
I o ~  
I Q I & H \_ @ { | HF HJ b  
E ;  
g o 2:  
I 8 \*  
I  
I !  
O 2 : ' ! z ! 5  
5Y b+l  
\$ " ' ,  
: 9\_ g;  
I BC \* E # g \$  
I T% • H &>  
2  
I  
z g : 89 '  
y \$ O { o ~

---

---

> { E& H ' ( ;

| u \$

| ' (

| ) \$

| \* \* +

|

| { | } Q H

8

, - \$ ' 45 t .

e1 o



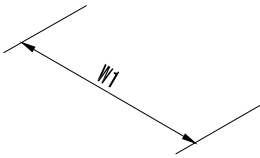

1

:mm

e2

p

Rc		—o	o ~ • kVA	—o • A	Vo • A	op • kW
ALPHA6000M	S2R4GB	1PH 220V 50/60Hz @ 176)	1.0	5.1	2.4	0.4
	S2R75GB		1.7	9.2	4.5	0.75
	S21R5GB	264V 9 /	2.8	13.1	7.0	1.5
	S22R2GB	5%	4.0	23 0.48 r52 re f78 Tj123.2.5		

S

@	0) @
	G 150% 1 b c 180% 20   P : 120% 1 b c 150% 1
	J /
	0.00) 650.0Hz 0.0) 1000Hz j
	Z / 0.01" -10( ) +40( Z / 0.01" 25( / 10(
\$ bu	Z 0.01Hz Z 1/1000
bu	0.01Hz
\$	0) 10V 0) 20mA
2	0.1) 3600   2 3\$
	125%
@/ }	4 V/F } g 5 V/F } \$ = PG V/F
	@ u@ ^ x, , @ W u@ 6J 6J J W
	-10( ) +40( @

### e3 K MODBUS

PLC \$ MODBUS 5 u  
 I MODBUS " 1| (PLC) F1) 31| " B 2  
 z 2 1| 2 \$ • - Z  
 2 Z P CJ

	RS-485
	@
	1200/2400/4800/9600/19200/38400bps RX / / WX # RTU 8 ASCII 7 8 p RTU 1 ASCII WX21 WX22
5	MODBUS RTU ASCII j
	31

I wx  
 MODBUS wx 485+ 485-wx  
 I 2 45; <  
 (1) W { | bN  
 (2) Q mn mn wx. 8w I ( pKL ~  
 )  
 PLC  
 1. U9 PLC F I  
 2. U  
 3. ^\_ \$ (Pb.00) Pb.08)  
 4. 9 U ^\_` / g  
 5. U  
 6. PLC

I \$  
 PLC 2 \$ : & S 4 5  
 PO.03 PO.04 PO.07 PO.11 P7.00 P7.01 P7.03 P7.04 P8.11 P9.19 Pd.02 Pd.04  
 Pb.00) Pb.08 Pd.16  
 \*4 1: I S \$ G O tZ O J s+ 02H  
 \*4 2: O• } F WX E +(T M \$ OE . F  
 { <\$ (T8T s+ 43 o  
 \*4 3: \$ - \$ 02 Z - OZ \$ ->02 -  
 E 3 E

I - KL H { 1  
 F WX H :  
 I 5  
 2 (PLC ) Z Z o z 88 O TD

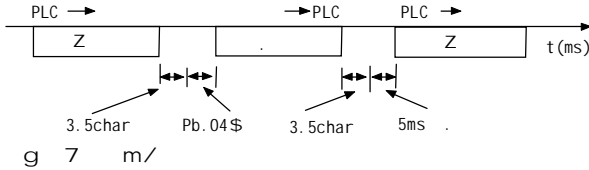

B	-	Z	o	CRCWX	2_
3.5char	1 char	1 char	n char	2 char	3.5char

WX CRC-16 WX CRCWX :  
 1 8W CRC-16 2 B 0 z w B \$ 1 (16 1)  
 2 - LSB MSB MSB LSB CRC-16  
 3 Z 3 CRC-16 Z CRC-16 !  
 2 MODBUS-ASCII  
 ASCII 7 2 : A ASCII 3AH 73 A ASCII 0DH,0AH  
 7 F 73 2 A ! 0) 9 A) F O j ASCII  
 4 4 LRCWX - Z o WX WX  
 WX AF 45 = 872 2 # 1| s+t  
 n 2 o~ /" 2 / 1ms 8 ~ 7 /

B	-	Z	o	LRCWX	2_A
1 char 3AH	2 char	2 char	n char	2 char	2 char 0DH 0AH

def

(0) 31) \$ 02 ghZ l

I Z

# MODBUS Z 4

Z (16)		Z #		. #		. #	
		/		/		/	
03H		8	8	7	7	5	5
06H	○	8	8	8	8	5	5
08H		8	8	8	8	5	5
10H	○	11	11	8	8	5	5

I

注：下文指令内容全部为16进制数据；

[03H]

Z Z 1 o ob 8 F 8 , .  
 o 8j b  
 1

RTU

Z	O	O
01	01	01
03	03	83
00	02	03
20	00	01
00	C1	31
01	79	
85	D4	
CRC	C0	

45                      -                      2q

ASCII

Z            3A 3031 3033 3030 3230 3030 3031 4442 0D0A            LRCWX DB  
 .            3A 3031 3033 3032 3030 4331 3339 0D0A            LRCWX 39  
 .            3A 3031 3833 3033 3739 0D0A            LRCWX 79

[06H]

O            Z            O            Z            Z            Z            Z            ( T  
 8            8            ,            Z            O            .            .            .  
 1

RTU

Z	O	O
01	01	01
06	06	86
00	00	02
01	01	C3
00	00	A1
01	01	
19	19	
CRC	CA	

ASCII

Z            3A 3031 3036 3030 3031 3030 3031 4637 0D0A            LRCWX F7  
 .            3A 3031 3036 3030 3031 3030 3031 4637 0D0A            LRCWX F7  
 .            3A 3031 3836 3032 3737 0D0A            LRCWX 77

[08H]

W            Z            Z            o t b            .            }            C J            6  
 g 5  
 WCJ

RTU

Z	O	O
01	01	01
08	08	88
00	00	03
00	00	06
12	12	01
34	34	
ED	ED	
CRC	7C	

ASCII

Z            8A 3031 3038 3030 3030 3132 3334 4231 0D0AA03 3D0A

30U300 30

[10H]

O 8  
\$

Z O Z . C

O ( T ,

RTU

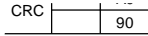
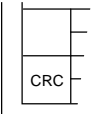

45 - 2q

ASCII

Z 30 3030 3032 3030 3031 3032 3  
30 3030 3032 3030 3031 4543 0  
30 3033 3643 0D0A

0D0A LRCWX 4F  
LRCWX EC  
LRCWX 6C

[10H]

MODBUS

- 0x00FF t O EEPROM

J \$

t 3

3 , Z O 00FFH

K

Hz EEPROM

RTU

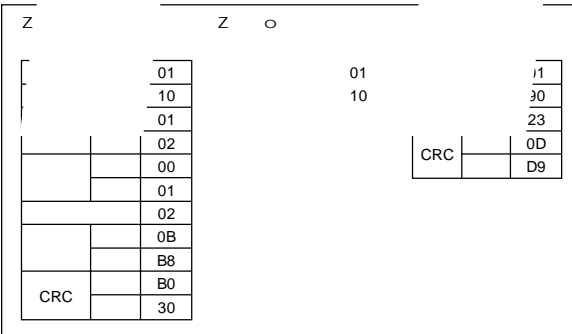

RTU U

Z	0	01	0	01		0	01
Z		10		10			90
		00		00			03
		01		01	CRC		0C
		00		00			01
		02		02			
		04		10			
		00		08			
		01					
		13					
		88					
		6E					
CRC		F5					

2q

ASCII U



3 MODBUS

MODBUS -	bit	O			
0026H	A12	(V)	0~10.00V	0~1000	
0027H		(A)			
0028H		@ (V)			
0029H	\$	Hz			
002AH	j				
002BH	w x	0	wx X1	1	0
		1	wx X2	1	0
		2	wx X3	1	0
		3	wx X4	1	0
		4	wx X5	1	0
		5	wx X6	1	0
6-F	j				
002CH	( j )				
002DH	0	DO	1	ON	0 OFF
	1	j			
	2	TA-TB-TC	1	ON	0 OFF
	3-F	j			
002EH	AO1	V	0~10.00V	0~1000	
002FH	j				
0030H	j				
0031H	k @				
0032H					
0033H	\$				
0034H	\$				
0035H					
0036H	\$				
0037H					
0038H	PID C J	(%)			
0039H	PID	(%)			
003AH	j				
003BH	j				
003CH	j				
003D-003FH	( j )				
0040-004AH	wx	0040HZ 004AHy	002BH	BIT0-BIT4	
004B-00FEH	( j )				

I Modbus - m:

m	(! DEC)	Modbus	(! HEX)
( n )			(00FH)
( Z )			(001H) 001FH
( o )			(0020H) 004FH
P0.00) P0.19			0100H) 0113H
P1.00) P1.24			0200H) 0218H
P2.00) P2.55			0300H) 0337H
P3.00) P3.36			0400H) 0424H
P4.00) P4.35			0500H) 0523H
P5.00) P5.36			0600H) 0624H
P7.00) P7.33			0800H) 0821H
P8.00) P8.28			0900H) 091CH
P9.00) P9.25			0A00H) 0A19H
PA.00) PA.30			0B00H) 0B1EH
Pb.00) Pb.08			0C00H) 0C08H
PC.00) PC.23			0D00H) 0D17H
Pd.00) Pd.37			0E00H) 0E2

m	(! DEC)	Modbus	(! HEX)
PF.00) PF.12		1000H) 100CH	71B+1@ 7. 4 4
( 89 )		(1100H) FFFFH)	

T f 7.

Modbus - :  
 F m 8 HI= 1 8 LO= .{ | - j

86m

	o
01H	Z o~ Z 03H 08H 10H
02H	- o~ - 1 : ENTER nK [0x00FFH] \$ - 41
03H	o~ O 1 . 16 O Z U2
21H	\$ o~ E. o~
22H	O o~ O O I O 42 O 43 t K O E CCF3 EEPROM 2O
23H	u@2O E Uu 2O
24H	I O D 2 2 2
25H	CRCWX 44

DD4T@D) Tj, 0 Tc (7hi@) Tj

' 1 \$ P0.03 P0.04 \$ O - 00022 \$ P0.07 & O  
 - 00012  
 ' 2 \$ z 86m O MN

e4

4.1 - .

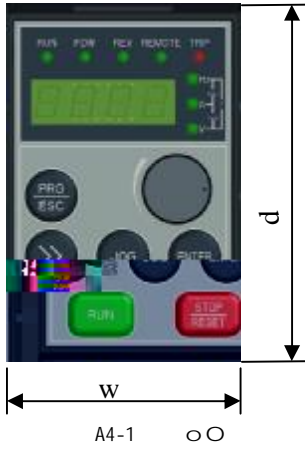

A4-1 mm

	w	d
S2R4GB S22R2GB 3R75GB 3004GB	49 0.2	76.5 0.2
35R5GB	61 0.2	96.5 0.2

4 ^ \_ b { ? ^ \_ F = @A ^ \_ { ^ \_ 8

4.2 - . / .



A4-2 mm

e5 ;

;

-	
	=
>	2?

7

KW	H
E2 s U	" {
%	
` / OC OL OU OH LU	{
wx	
	@
2 :	/ 2

67

U @ U-V V V-W V W-U V	
@ o KVA	
v U <sub>#</sub> N m	v <sub>#</sub> N m
( 8W	@@ 8W
{   67	